



TUFFRO

The Mangalm Surgical Co.

Dental



500/1
1
17 cm

650/1
1
17 cm

Schneide- und Eckzähne
Incisors and cuspids
Incisives et canines
Incisivos y caninos
Denti incisivi medi e denti canini



500/7
7
16 cm

650/7
7
16 cm

Prämolaren
Biscuspids
Prémolaires
Premolares
Denti premolari



500/17
17
17 cm

650/17
17
17 cm

Molaren, rechts
Molars, right
Molaires, droit
Molares, derecho
Denti molari, destra



500/18
18
17 cm

650/18
18
17 cm

Molaren, links
Molars, left
Molaires, gauche
Molares, izquierdo
Denti molari, sinistra



500/29
29
17 cm

650/29
29
17 cm

Wurzeln
Roots
Racines
Raíces
Radici



TUFFRO

The Mangalm Surgical Co.



500/51 A
51A
18,5 cm

650/51 A
51A
18,5 cm

Wurzeln
Roots
Racines
Raíces
Radici



500/67 A
67A
17 cm

650/67 A
67A
17 cm

Dritte Molaren
Third molars
Troisièmes molaires
Terceros molares
Denti del giudizio



Dental



TUFFRO

The Mangalm Surgical Co.

Dental



500/4
4
16 cm

650/4
4
16 cm

Schneide- und Eckzähne
Incisors and cuspids
Incisives et canines
Incisivos y caninos
Denti incisivi medi e denti canini

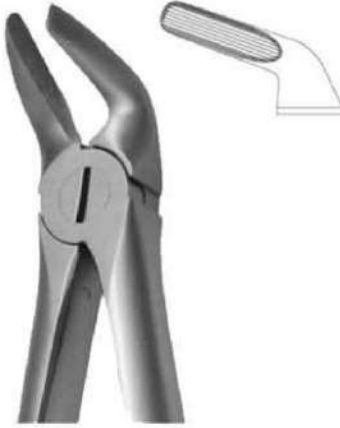

500/8
8
16 cm

650/8
8
16 cm

Prämolaren
Biscuspids
Prémolaires
Premolares
Denti premolari



500/13
13
15,5 cm

650/13
13
15,5 cm

Prämolaren
Biscuspids
Prémolaires
Premolares
Denti premolari



500/22
22
15,5 cm

650/22
22
15,5 cm

Molaren
Molars
Molaires
Molares
Denti molari



500/33 A
33 A
15 cm

650/33 A
33 A
15 cm

Wurzeln
Roots
Racines
Raíces
Radici



TUFFRO

The Mangalm Surgical Co.



500/45
45
17 cm



650/45
45
17 cm

Wurzeln
Roots
Racines
Raíces
Radici



500/74
74
15 cm



650/74
74
15 cm

Wurzeln
Roots
Racines
Raíces
Radici



500/74 XN
74 XN
14,5 cm



650/74 XN
74 XN
14,5 cm

Schneidezähne & Wurzeln
Incisors & Roots
Incisivos & Racines
Incisivos & Raíces
Denti incisivi & Radici



500/79
79
17 cm



Dritte Molaren
Third molars
Troisième molaires
Terceros molares
Denti del giudizio



500/79 A
79 A
17 cm



650/79 A
79 A
17 cm

Dritte Molaren
Third molars
Troisième molaires
Terceros molares
Denti del giudizio



500/87
87
16 cm



Molaren
Molars
Molaires
Molares
Denti molari

Dental



TUFFRO

The Mangalm Surgical Co.

Dental



1101 / P
1
17 cm

1101
1
17 cm

Schneide- und Eckzähne
Incisors and cuspids
Incisives et canines
Incisivos y caninos
Denti incisivi medi e denti canini



1102 P
2
17,5 cm

1102
2
17,5 cm

1102 D
2
17,5 cm



Schneide- und Eckzähne
Incisors and cuspids
Incisives et canines
Incisivos y caninos
Denti incisivi medi e denti canini

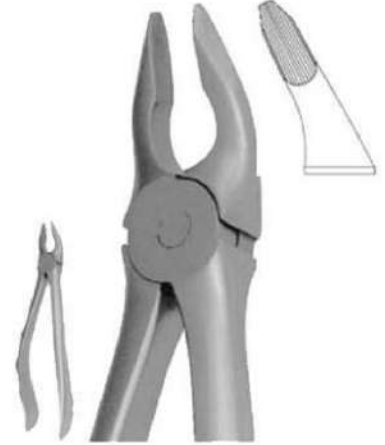

1107 P
7
16,5 cm

1107
7
16,5 cm

1107 D
7
16,5 cm



Prämolaren
Bicuspidis
Prémolaires
Premolares
Denti premolari



1107 NP
7 N
16 cm

1107 N
7 N
16 cm

Prämolaren
Bicuspidis
Prémolaires
Premolares
Denti premolari



TUFFRO

The Mangalm Surgical Co.

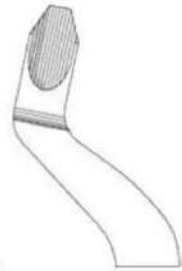
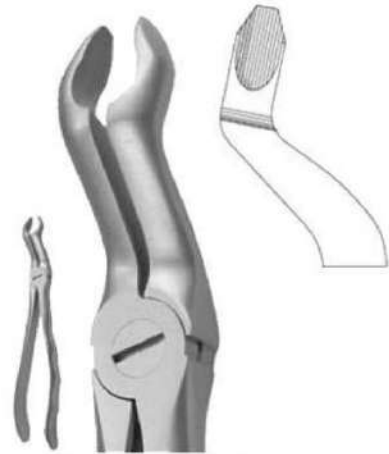
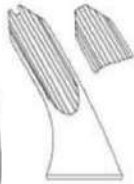

1118 P
18
17 cm

1118
18
17 cm

Molaren, links
Molars, left
Molaires, gauche
Molares, izquierdo
Denti molari, sinistra

1167 P
67
17,5 cm

1167
67
17,5 cm

Dritte Molaren
Third molars
Troisièmes molaires
Terceros molares
Denti del giudizio

1117 P
17
17 cm

1117
17
17 cm

Molaren, rechts
Molars, right
Molaires, droit
Molares, derecho
Denti molari, destra

Dental



TUFFRO

The Mangalm Surgical Co.

Dental



1122 P
22
15 cm

1122 K
22
15 cm

Molaren
Molars
Molaires
Molares
Denti molari

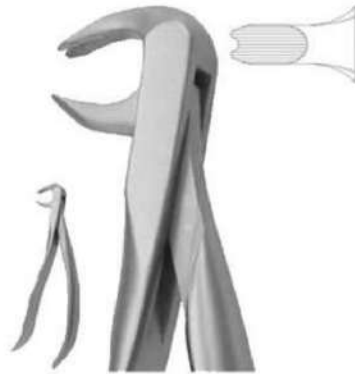

1173 P
73
14 cm

1173 K
73
14 cm

Molaren
Molars
Molaires
Molares
Denti molari

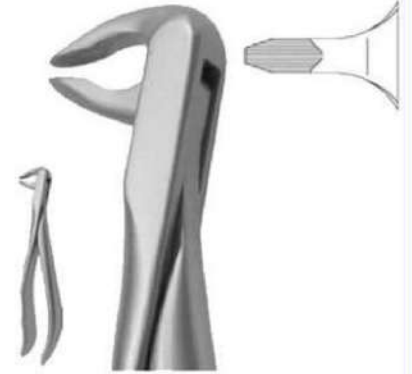

1174 P
74
15 cm

1174
74
15 cm

1174 D
74
15 cm



Schneide- und Eckzähne
Incisors and cuspids
Incisives et canines
Incisivos y caninos
Denti incisivi medi e denti canini



1108 P
8
16,5 cm

1108
8
16,5 cm

Prämolaren
Bicuspidis
Prémolaires
Premolares
Denti premolari



1174 NP
74 N
14,5 cm

1174 N
74 N
14,5 cm

Prämolaren
Biscuspids
Prémolaires
Premolares
Denti premolari



1174 XNP
74 XN
14,5 cm

1174 XN
74 XN
14,5 cm

Prämolaren
Biscuspids
Prémolaires
Premolares
Denti premolari

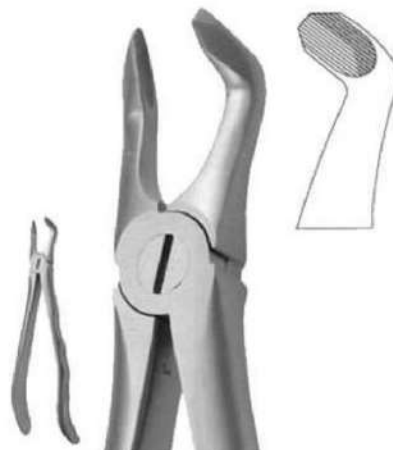

1179 AP
79 A
17 cm

1179 A
79 A
17 cm

Dritte Molaren
Third molars
Troisièmes molaires
Terceros molares
Denti del giudizio





TUFFRO

The Mangalm Surgical Co.

Dental



1229 EP
29 E
17 cm

1229 E
29 E
17 cm

1229 ES
29 E
17 cm

Wurzeln
Roots
Racines
Raíces
Radici

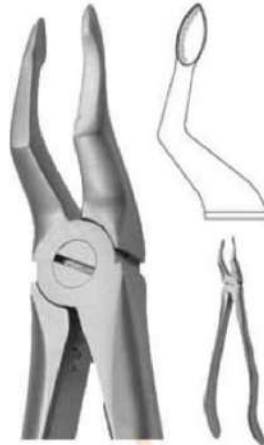

1251 EP
51 E
16 cm

1251 E
51 E
16 cm

1251 EPS
51 E
16 cm

1251 ES
51 E
16 cm

Wurzeln
Roots
Racines
Raíces
Radici

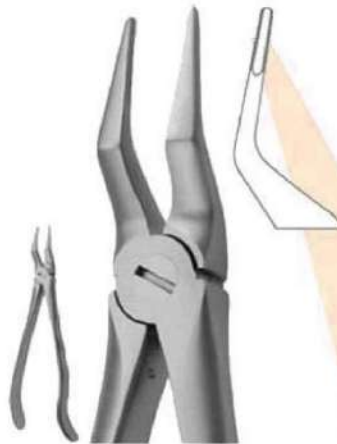

1251 NP
51 N
16,5 cm

1251 N
51 N
16,5 cm

1251 ND
51 N
16,5 cm

Wurzeln
Roots
Racines
Raíces
Radici

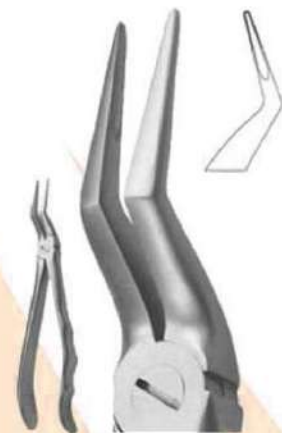

1296 AP
96 A
19,5 cm

Wurzeln
Roots
Racines
Raíces
Radici



TUFFRO

The Mangalm Surgical Co.

Dental



1245 P
45
17 cm

1245
45
17 cm

1245 D
45
17 cm



Wurzeln
Roots
Racines
Raíces
Radici



1246 P
46
19 cm

Wurzeln
Roots
Racines
Raíces
Radici



1274 EP
74 E
14,5 cm

1274 E
74 E
14,5 cm

1274 EPS
74 E
14,5 cm

1274 ES
74 E
14,5 cm

Wurzeln
Roots
Racines
Raíces
Radici



1249 P
49
17,5 cm

1249
49
17,5 cm

1249 PS
49
17,5 cm

1249 S
49
17,5 cm

Wurzeln
Roots
Racines
Raíces
Radici



1290 AP
90 A
15 cm

1290 A
90 A
15 cm

Wurzeln
Roots
Racines
Raíces
Radici



TUFFRO

The Mangalm Surgical Co.

Dental



500 / 37
37
14,5 cm

Schneidezähne- und Eckzähne
Incisors and cuspids
Incisives et canines
Incisivos y caninos
Denti incisivi e denti canini



500/39 R
39 R
14,5 cm

650/39 R
39 R
14,5 cm

Molaren, rechts
Molars, right
Molaires, droit
Molares, derecho
Denti molari, destra



500/39 L
39 L
14,5 cm

650/39 L
39 L
14,5 cm

Molaren, links
Molars, left
Molaires, gauche
Molares, izquierdo
Denti molari, sinistra



TUFFRO

The Mangalm Surgical Co.



560
Klein # 137
10,5 cm

Schneidezähne- und Eckzähne
Incisors and cuspids
Incisives et canines
Incisivos y caninos
Denti incisivi e denti canini



561
Klein # 139
10,5 cm

Prämolaren
Biscuspids
Prémolaires
Premolares
Denti premolari

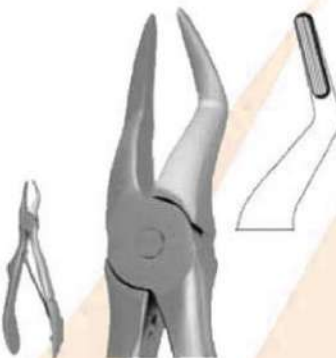

562
Klein # 51 S
12 cm

Wurzeln
Roots
Racines
Raíces
Radici

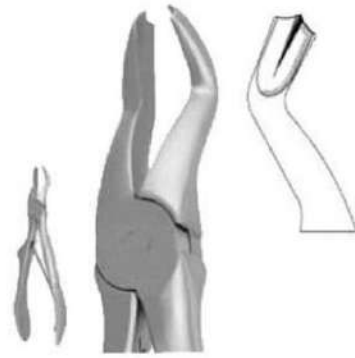

563
Klein # 3
12 cm

Molaren
Molars
Molaires
Molares
Denti molari

Dental



TUFFRO

The Mangalm Surgical Co.

Dental



600/101 AS
101 AS
15,5 cm

600/101 ASP
101 AS
15,5 cm

Zähne, universal
Teeth, universal
Dentes, universal
Dientes, universal
Denti, universale



600/150 AS
150 AS
15,5 cm

Zähne, universal
Teeth, universal
Dentes, universal
Dientes, universal
Denti, universale



600/150 S
Cryer # 150 S
15,5 cm

Zähne und Wurzeln, universal
Teeth and roots, universal
Dentes et racines, universal
Dientes y raíces, universal
Denti e radici, universale

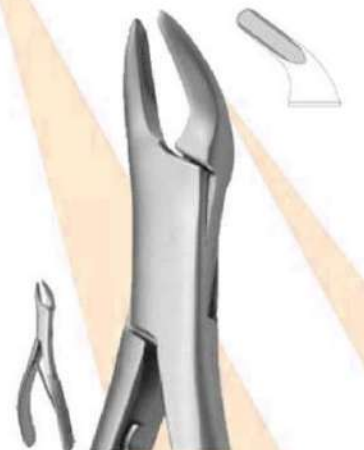

645/150 SK
150 SK
12,5 cm

645/150 SKP
150 SK
12,5 cm

Zähne und Wurzeln, universal
Teeth and roots, universal
Dentes et racines, universal
Dientes y raíces, universal
Denti e radici, universale



TUFFRO

The Mangalm Surgical Co.



133 AS

12,5 cm

133 ASP

12,5 cm

Zähne, universal
Teeth, universal
Dentes, universal
Dientes, universal
Denti, universale



500/13 S

13 S
13 cm

Prämolaren
Biscuspids
Prémolaires
Premolares
Denti premolari



500/22 S

22 S
13 cm

650/22 S

22 S
13 cm

Molaren
Molars
Molaires
Molares
Denti molari



565

Klein # 5
10,5 cm

Schneidezähne
Incisors
Incisives
Incisivos
Denti incisivi



566

Klein # 6
10,5 cm

Molaren
Molars
Molaires
Molares
Denti molari



567

Klein # 7
10,5 cm

Wurzeln
Roots
Racines
Raices
Radici

Dental



TUFFRO

The Mangalm Surgical Co.

Dental



1402/17
15,5 cm



1402/33
15,5 cm

1402/23
15 cm

Rundgriff massiv
Round handle solid
Manche rond massive
Mango redando sólido
Manico tondo solida



1410/1
15 cm

Achtkantgriff massiv / gerieft
Octagonal handle solid / serrated
Manche octagonal massive / striée
Mango octagonal sólido / estriado
Manico ottagonale solida / zigrinate



1410/2
15 cm



1410/32
14,5 cm



1410/34
15 cm



1410/44
15 cm



1420/33
15 cm



1410/33 G
15 cm



1410/30
15 cm



1410/33
15 cm



1410/43
15 cm



1415/33
15 cm



1410/32 SE
3,5 cm

Sonden auswechselbar
Explorers interchangeable
Sondes échangeables
Sondas cambiables
Sonde sostitutive



1410/33 SE
4 cm

Einsatz für Mundspiegelgriffe S. 11
Insert for mouth mirror handle S. 11
Insert pour manches à miroirs S. 11
Pieza de inserción para mangos a espejos S. 11
Inserto per manici specchietti S. 11

1410/17 G
15 cm

Rundgriff massiv
Round handle solid
Manche rond massive
Mango redando sólido
Manico tondo solida



TUFFRO

The Mangalm Surgical Co.

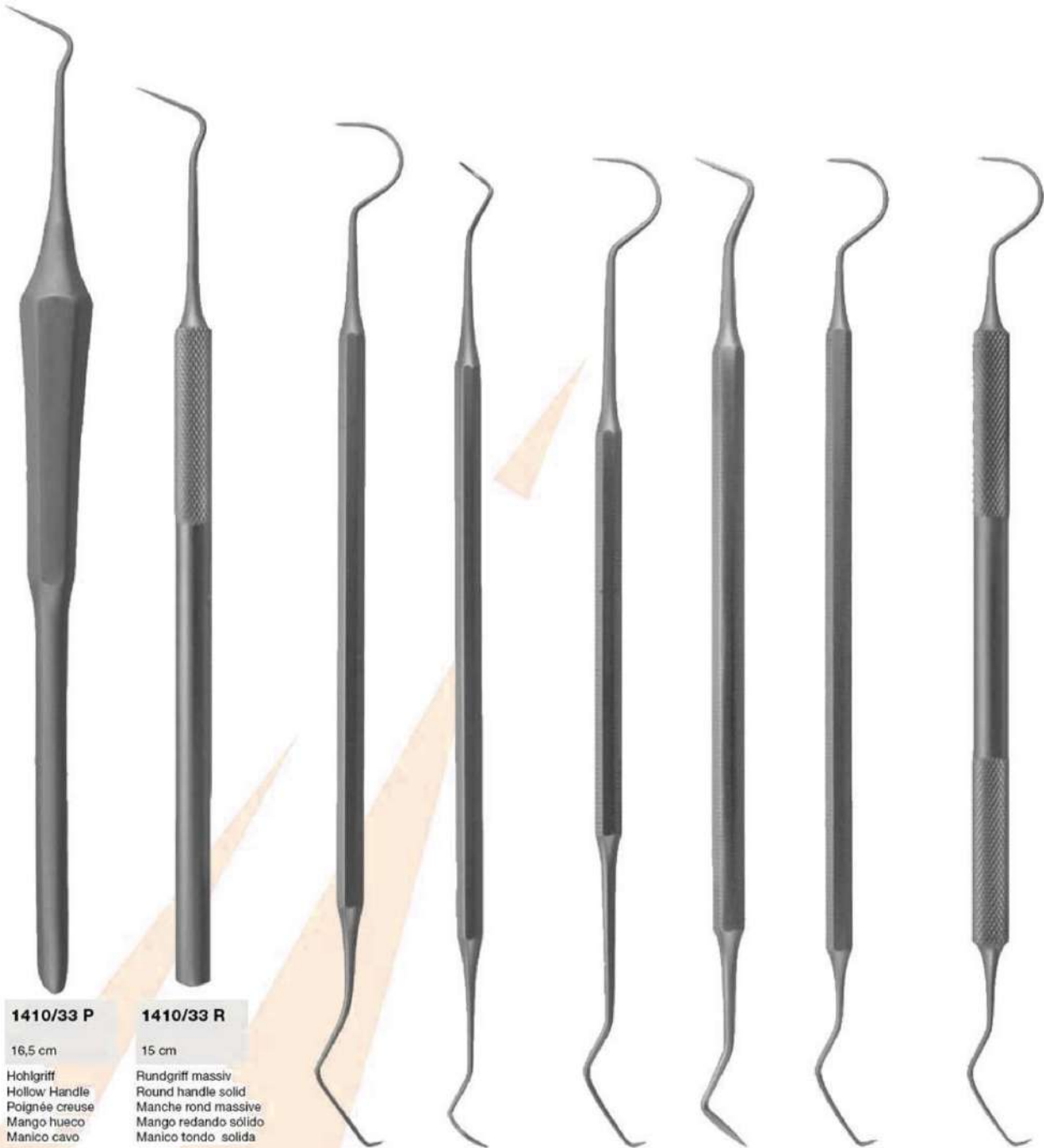

1410/33 P

16,5 cm

Hohlgriff
Hollow Handle
Poignée creuse
Mango hueco
Manico cavo

1410/33 R

15 cm

Rundgriff massiv
Round handle solid
Manche rond massive
Mango redando sólido
Manico tondo solida

1435/5

17 cm

Achtkantgriff / massiv / glatt
Octagonal handle / solid / smooth
Manche octogonal / massive / lisse
Mango octogonal / sólido / lisa
Manico ottagonale / solida / lisce

1435/7

16,5 cm

1440/5

16,5 cm

Achtkantgriff / massiv / gerieft
Octagonal handle / solid / serrated
Manche octogonal / massive / striée
Mango octogonal / sólido / estriado
Manico ottagonale / solida / ziginate

1455/1

Lange
16,5 cm

1440/5 A

16,5 cm

1440/5 AR

16,5 cm

Rundgriff / massiv
Round handle / solid
Manche rond / massive
Mango redando / sólido
Manico tondo / solida

Dental



TUFFRO

The Mangalm Surgical Co.

Dental

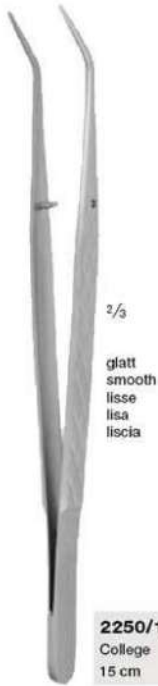

2/3
glatt
smooth
lisse
lisa
liscia

2250/1
College
15 cm

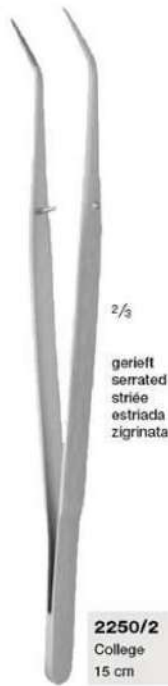

2/3
gerieft
serrated
striée
estriada
zigrinata

2250/2
College
15 cm



2/3
gerieft
serrated
striée
estriada
zigrinata

2255/2
College
15 cm

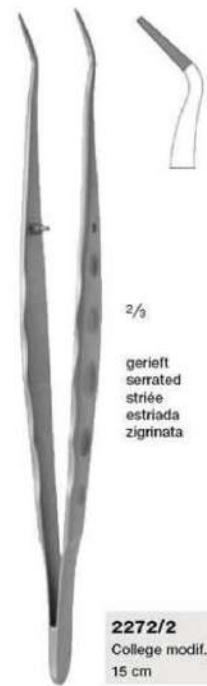

2/3
gerieft
serrated
striée
estriada
zigrinata

2272/2
College modif.
15 cm

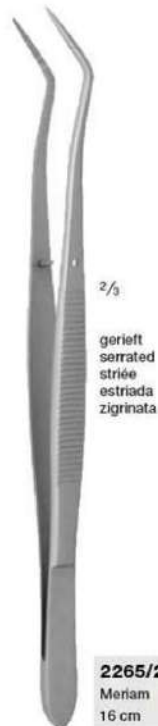

2/3
gerieft
serrated
striée
estriada
zigrinata

2265/2
Meriam
16 cm



2/3
diamantierte Spitzen
diamonded tips
pointes diamantées
puntas diamantadas
punte diamantate

2265 D
Meriam
16 cm

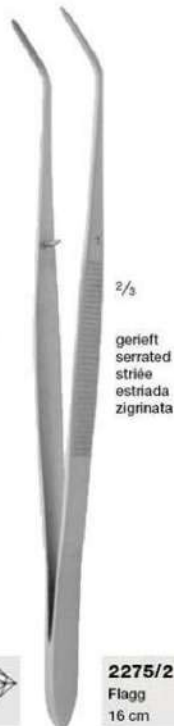

2/3
gerieft
serrated
striée
estriada
zigrinata

2275/2
Flagg
16 cm



2/3
gerieft
serrated
striée
estriada
zigrinata

2295/2
14,5 cm



2/3
gerieft
serrated
striée
estriada
zigrinata

2285/2
Perry
13 cm



TUFFRO

The Mangalm Surgical Co.



2380
12,5 cm

hohl verchromt
hollow chromium
plated creux chromé
hueco cromado
cavo cromato



2382
12 cm

massiv
solid
massive
solido
solida



2384
14 cm

Hohlgriff
Hollow Handle
Poignée creuse
Mango hueco
Manico cavo



2390
13 cm

Hohlgriff
Hollow Handle
Poignée creuse
Mango hueco
Manico cavo



2395
13,5 cm

Kunststoffgriff grün
Plastic handle green
Manche à plastique vert
Mango plastico verde
Manico plastica verde

2395 B
13,5 cm

Kunststoffgriff blau
Plastic handle blue
Manche à plastique bleu
Mango plastico amaratado
Manico plastica blu

2395/1
13,5 cm

Kunststoffgriff schwarz
Plastic handle black
Manche à plastique noir
Mango plastico negro
Manico plastica nero



2399
13,5 cm

Hohlgriff
Hollow Handle
Poignée creuse
Mango hueco
Manico cavo

2399 A
Cone-Socket
13 cm

Hohlgriff
Hollow Handle
Poignée creuse
Mango hueco
Manico cavo

Dental



TUFFRO

The Mangalm Surgical Co.

Dental



2340/4 *3)
ø 22 mm

2342/4 *1)
ø 22 mm



2350/4 *3)
ø 22 mm

2350/5 *3)
ø 24 mm



2370/4 *3)
ø 22 mm

2370/5 *3)
ø 24 mm

2352/4 *1)
ø 22 mm

2352/5 *1)
ø 24 mm

2372/4 *1)
ø 22 mm

2372/5 *1)
ø 24 mm

2360/4 *2,3)
ø 22 mm

2360/5 *2,3)
ø 24 mm

2362/4 *1,2)
ø 22 mm

2362/5 *1,2)
ø 24 mm



2374/4 *1,4)
ø 22 mm
Rhodium

2374/5 *1,4)
ø 24 mm
Rhodium



2377/4 *1,4)
ø 22 mm
Rhodium



2378/4 *1,4)
ø 22 mm
HR-Front

2378/5 *1,4)
ø 24 mm
HR-Front

- *1) plan / plane / plan / plano / piano
- *2) hauchfrei / not tarnishing / antibuée / no empanan / privo di profumo
- *3) vergrößernd / magnifying / agrandissant / de aumento / concavo
- *4) absolut verzerrungsfreies Spiegelbild / absolutely distortion-free mirror image
image réfléchi sans aucune distorsion / imagen reflejada totalmente libre de distorsión
immagine riflessa assolutamente priva die distorsioni



TUFFRO

The Mangalm Surgical Co.

Dental



EXC 1 Z
17
16 cm

EXC 1 SZ
16 cm

EXC 11 Z
11
16 cm

Neuer **LIGHTWEIGHT** Griff
New **LIGHTWEIGHT** handle
Neuf manche **LIGHTWEIGHT**
Nuevo mango **LIGHTWEIGHT**
Nuovo manico **LIGHTWEIGHT**



1290/17
White
17 cm

1295-45-46
#45-46
16 cm

1295-51-52
#51-52
16 cm

1295-63-64
#63-64
16 cm

1295-81-82
#81-82
16 cm

Achtkantgriff / massiv / gerieft
Octagonal handle / solid / serrated
Manche octagonal / massive / striée
Mango octagonal / sólido / estriado
Manico ottagonale / solida / zigrinate



TUFFRO

The Mangalm Surgical Co.

Dental

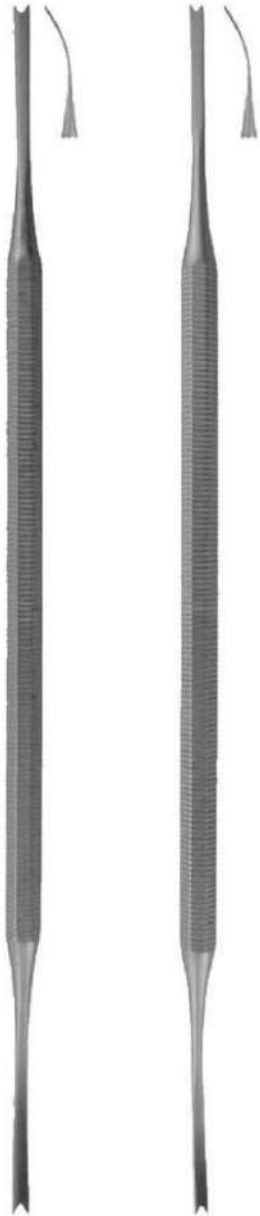

1020/1
Lunlatschek
18 cm

Tamponstopfer
Gauze Packer
Porte Tampon
Tamponadore
Reggitampone

Achtkantgriff / massiv / gerieft
Octagonal handle / solid / serrated
Manche octagonal / massive / striée
Mango octagonal / sólido / estriado
Manico ottagonale / solida / zigrinate

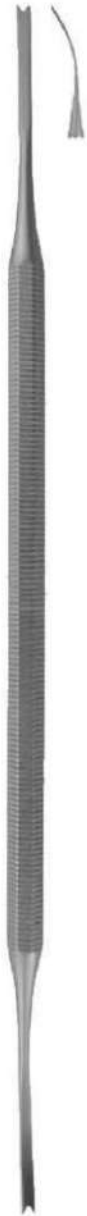

1020/2
Lunlatschek
18 cm

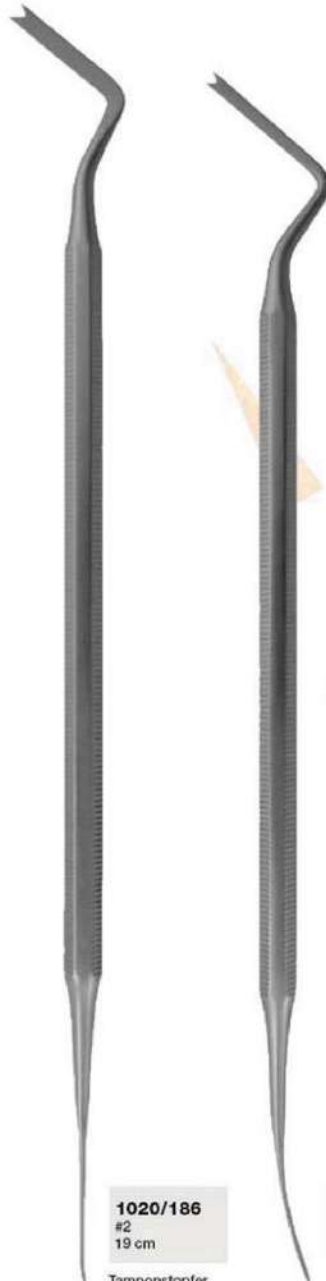

1020/186
#2
19 cm

Tamponstopfer
Gauze Packer
Porte Tampon
Tamponadore
Reggitampone

Achtkantgriff / massiv / gerieft
Octagonal handle / solid / serrated
Manche octagonal / massive / striée
Mango octagonal / sólido / estriado
Manico ottagonale / solida / zigrinate



1020/204
#2521
18 cm

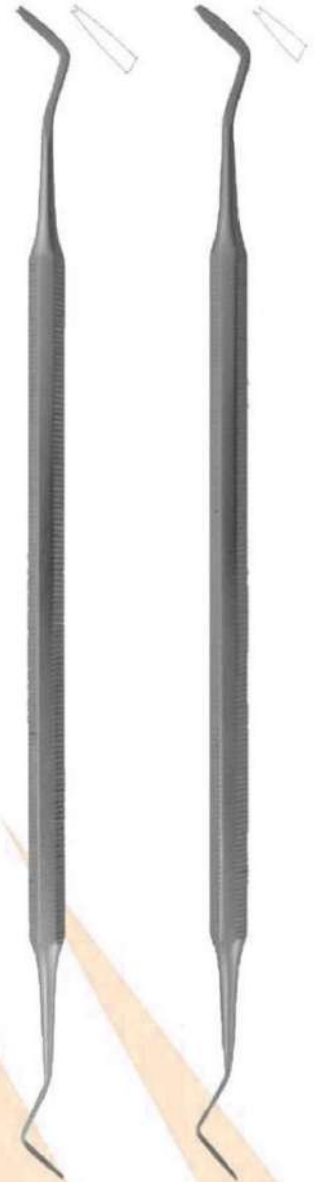

1020/6
17,5 cm

Fadenleger
Thread Packer
Porte-fil
Introdutor de hilo
Strumenti per fili die retrazione

Achtkantgriff / massiv / gerieft
Octagonal handle / solid / serrated
Manche octagonal / massive / striée
Mango octagonal / sólido / estriado
Manico ottagonale / solida / zigrinate



1020/7
17,5 cm



TUFFRO

The Mangalm Surgical Co.

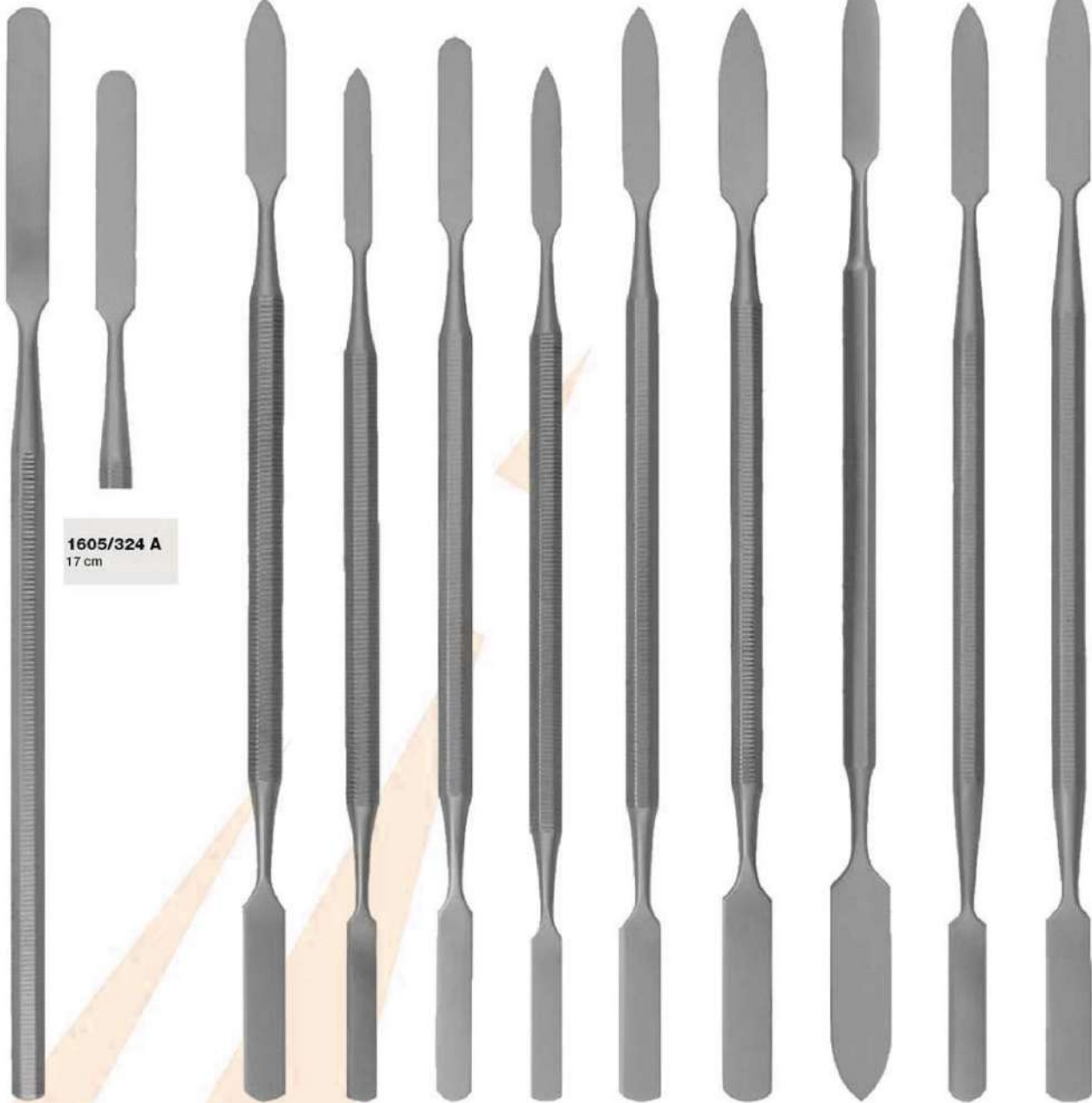

1605/324 A
17 cm

1605/324
18 cm

1650/1
18 cm

1650/2
17 cm

1650/3
17,5 cm

1655/1
17 cm

1655/2
18 cm

1655/3
18 cm

1655/4
18,5 cm

1660/2
18 cm

1660/4
18,5 cm

Achtkantgriff / massiv / gerieft
Octagonal handle / solid / serrated
Manche octagonal / massive / striée
Mango octagonal / sólido / estriado
Manico ottagonale / solida / zigrinate

Dental



TUFFRO

The Mangalm Surgical Co.

Dental



1276/1

10,5 cm

Rundgriff / massiv
Round handle / solid
Manche rond / massive
Mango redando / sólido
Manico tondo / solida



1700/1

1700/1 TI* 1)
ø0,8/ø1,2 mm
17 cm

Kugelstopfer
Ball-type condenser
Oburateur à bille
Condensador tipo bola
Otturatore a sfera



1700/2

1700/2 TI* 1)
ø1,2/ø1,8 mm
17 cm

Achtkantgriff / massiv / gerieft
Octagonal handle / solid / serrated
Manche octagonal / massive / striée
Mango octagonal / sólido / estriado
Manico ottagonale / solida / zigrinate



1700/3

1700/3 TI* 1)
ø1,8/ø2,4 mm
17 cm

* 1)
titanbeschichtet / nicht haftend
titanium-coated / non-adhesive
recouvert de titane / non-adhésif
con revestimiento de titanio / no adhesivo
con rivestimento in titanio / non adesivo



1700/4

ø2,4/ø3,2 mm
17 cm



2010/26-29

White
17 cm

Polierinstrument
Polisher
Polissoir
Instrumento para pulir
Lucidatore



2010/29-31

White
17 cm

Achtkantgriff / massiv / gerieft
Octagonal handle / solid / serrated
Manche octagonal / massive / striée
Mango octagonal / sólido / estriado
Manico ottagonale / solida / zigrinate



TUFFRO

The Mangalm Surgical Co.

Dental

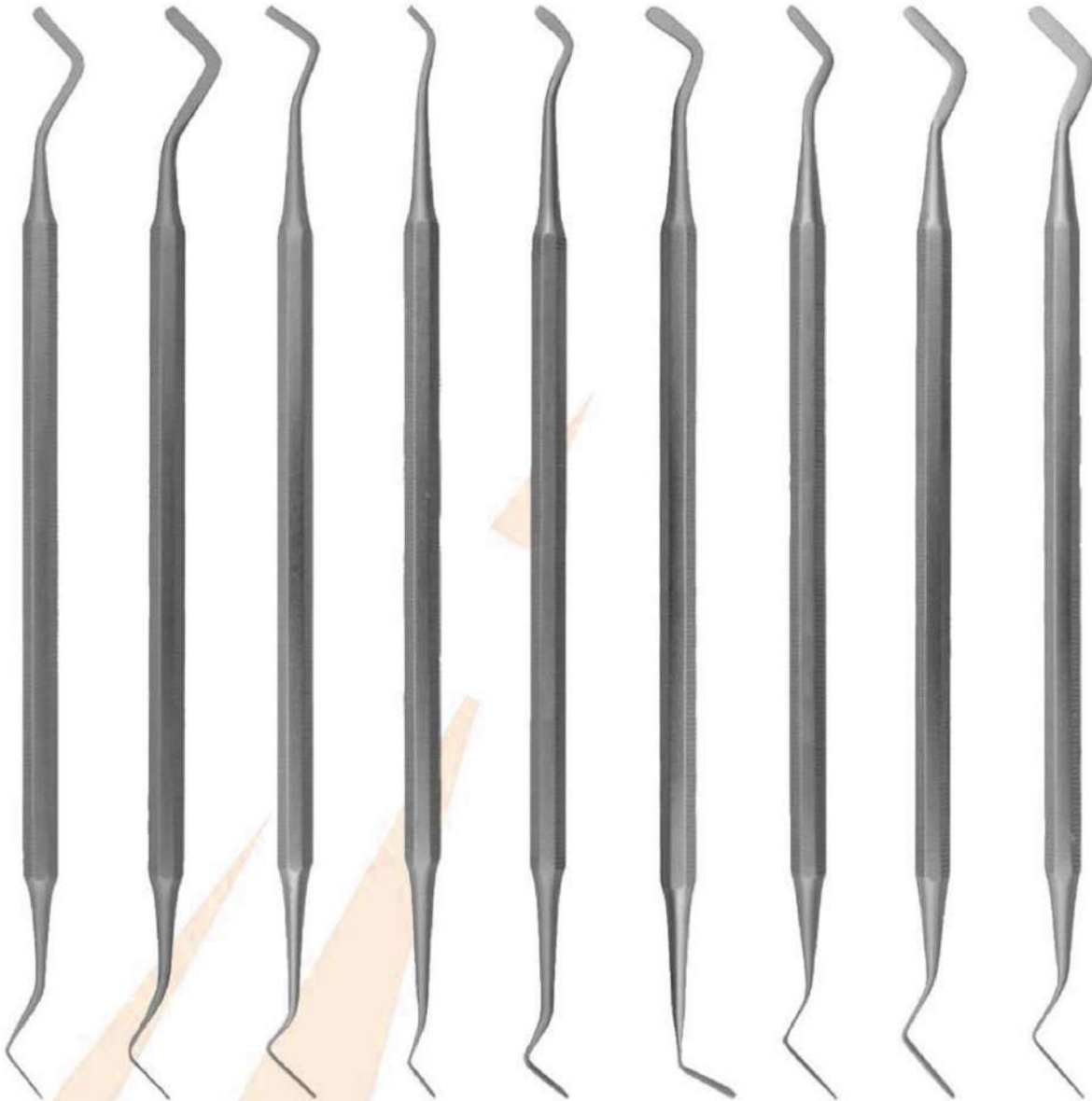

1700/13	1700/14	49 F	1900/0 1900/0 TI*1)	1900/1	1900/6	1960/1 1960/1 TI*1) Heidemann	1960/2 1960/2 TI*1) Heidemann	1960/3 Heidemann
1,5/1,5 mm 17 cm	2,0/2,0 mm 17 cm	2,5/1,8 mm 17,5 cm	1,4/2,0 mm 17 cm	2,0/2,0 mm 17 cm	2,6/3,2 mm 17 cm	2,1/2,1 mm 17 cm	2,7/2,7 mm 17 cm	3,1/3,1 mm 17 cm

Spatel
Spatula
Spatule
Espátula
Spatole

Achtkantgriff / massiv / gerieft
Octagonal handle / solid / serrated
Manche octagonal / massive / striée
Mango octagonal / sólido / estriado
Manico ottagonale / solida / zigrinate

*1)
titanbeschichtet / nicht haftend
titanium-coated / non-adhesive
recouvert de titane / non-adhésif
con revestimiento de titanio / no adhesivo
con rivestimento in titano / non adesivo



TUFFRO

The Mangalm Surgical Co.

Dental

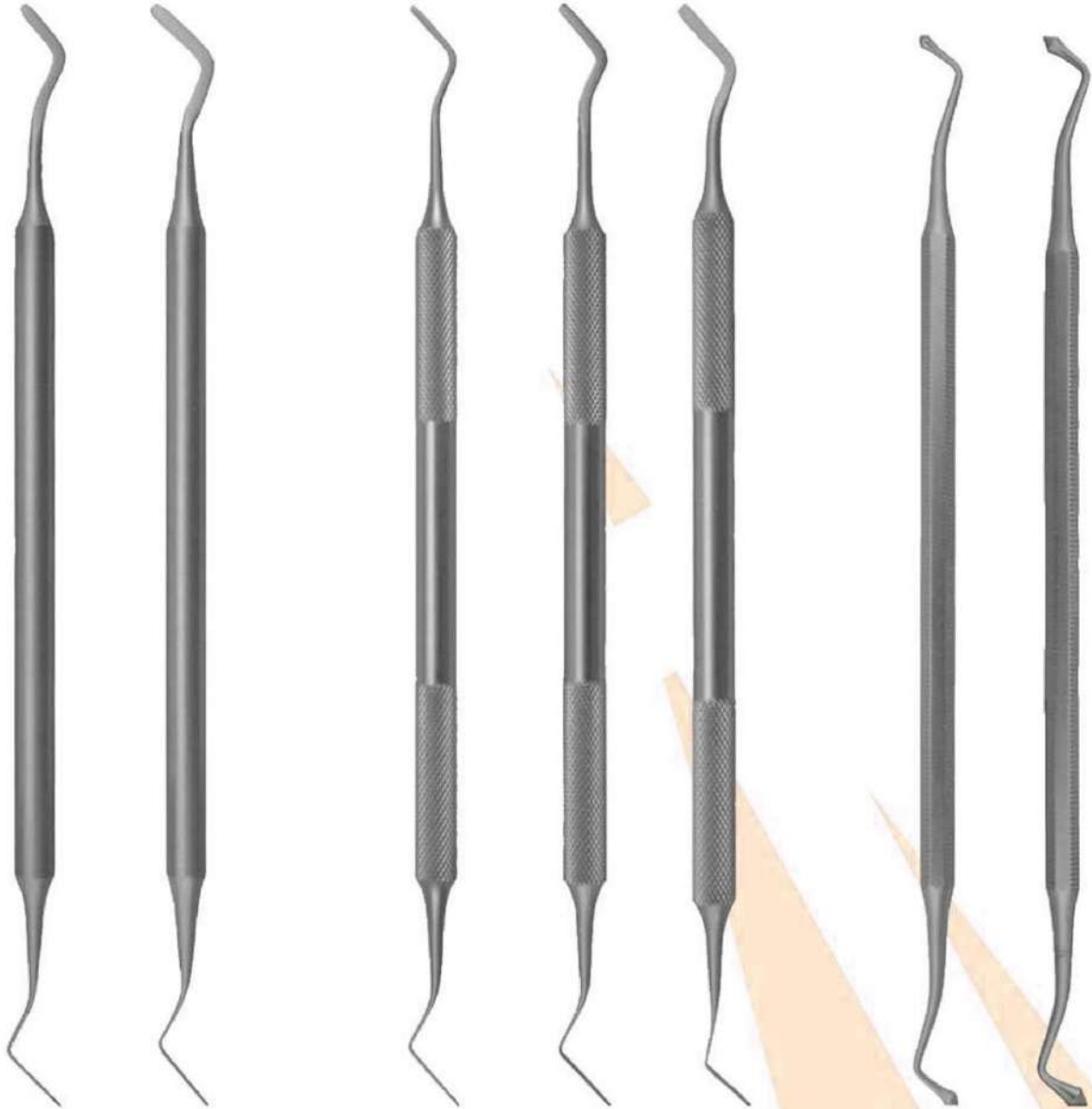

1960/1 G

2,1/2,1 mm
Heidemann
17,5 cm

Spatel
Spatula
Spatule
Espátula
Spatole

1960/2 G

2,7/2,7 mm
Heidemann
17,5 cm

Rundgriff / massiv
Round handle / solid
Manche rond / massive
Mango redando / sólido
Manico tondo / solida

1960/11 R

1,4/1,4 mm
Heidemann
17,5 cm

Spatel
Spatula
Spatule
Espátula
Spatole

Rundgriff / massiv / gerieft
Round handle / solid / serrated
Manche rond / massive / striée
Mango redando / sólido / estriado
Manico tondo / solida / zigrinate

**1960/1 R
1960/1 R TI*1)**

2,1/2,1 mm
Heidemann
17,5 cm

1960/8 R

2,5/2,5 mm
Heidemann
17,5 cm

**1790/21
1790/21 TI*1)**

2,4/2,8 mm
17 cm

Achtkantgriff / massiv / gerieft
Octagonal handle / solid / serrated
Manche octogonale / massive / striée
Mango octagonal / sólido / estriado
Manico ottagonale / solida / zigrinate

1790/21 B

3,0/3,4 mm
Westcott
17 cm

* 1)
titanbeschichtet / nicht haftend
titanium-coated / non-adhesive
recouvert de titane / non-adhésif
con revestimiento de titanio / no adhesivo
con rivestimento in titanio / non adesivo



TUFFRO

The Mangalm Surgical Co.



1700/35
1700/35 TI* 1)
0,9/1,2 mm
17 cm



1700/36
1700/36 TI* 1)
1,2/1,6 mm
17 cm



1700/37
1,6/2,1 mm
17 cm



1750/1-2
2,0/2,5 mm
17 cm

* 1)
titanbeschichtet / nicht haftend
titanium-coated / non-adhesive
recouvert de titane / non-adhésif
con revestimiento de titanio / no adhesivo
con rivestimento in titanio / non adesivo

Achtkantgriff / massiv / gerieft
Octagonal handle / solid / serrated
Manche octogonale / massive / striée
Mango octagonal / sólido / estriado
Manico ottagonale / solida / zigrinate

Dental



TUFFRO

The Mangalm Surgical Co.

Dental



1/2

Ø 11 mm

2421
13 cm



1/2

Ø 15,8 mm

2421/3
13 cm



Ø 3 mm

1/2

2422
19 cm



Ø 5 mm

1/2

2423
18,5 cm



Ø 3 mm

1/2

2425
14 cm



1/2

2424 B
16 cm



TUFFRO

The Mangalm Surgical Co.



2400/4
Ivory
20 cm



2477
Toffemire
6 cm



2477/1
Toffemire
6 cm



2477/2
Toffemire
6 cm



2477/3
Toffemire
6 cm



1/2

2582
Miller
15,5 cm



1/2

2583
Miller
15,5 cm

Dental



TUFFRO

The Mangalm Surgical Co.

Dental



2550/1
Ainsworth
16,5 cm

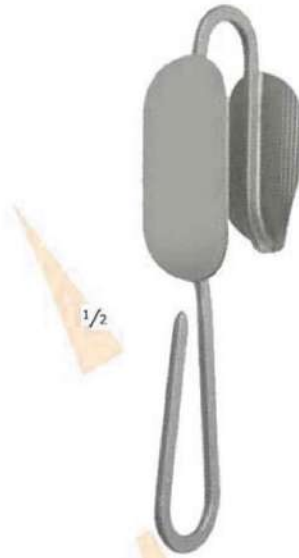

110
15 cm
Scheufele



120
17 cm
Scheufele

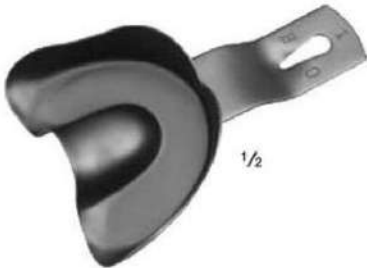

1/2

- 5101** = Fig. 1
- 5102** = Fig. 2
- 5103** = Fig. 3
- 5104** = Fig. 4

Form BO (SUP/B)
für bezahnte Oberkiefer, ungelocht
for toothed upper jaws, unperforated
Maxillaires dentés, non perforés
para mandíbulas superiores dentadas, no perforadas
per mascella superiore dentata, non perforata

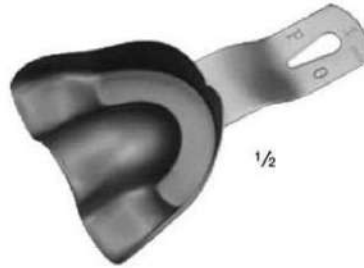

1/2

- 5121** = Fig. 1
- 5122** = Fig. 2

Form PO (SUP/P)
für partiell bezahnte Oberkiefer, ungelocht
for partially toothed upper jaws, unperforated
Maxillaires partiellement dentés, non perforés
para mandíbulas superiores parcialmente dentadas, no perforadas
per mascella superiore parzialmente dentata, non perforata

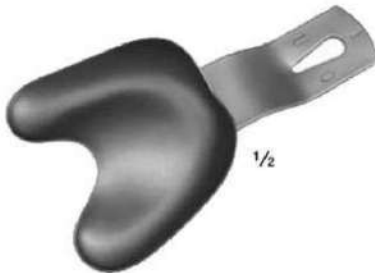

1/2

- 5131** = Fig. 1
- 5132** = Fig. 2

Form UO (SUP/U)
für unbezahnte Oberkiefer, ungelocht
for edentulous upper jaws, unperforated
Maxillaires édentés, non perforés
para mandíbulas desdentadas superiores, no perforadas
per mascella superiore edentula, non perforata



1/2

- 5151** = Fig. 1
- 5152** = Fig. 2
- 5153** = Fig. 3
- 5154** = Fig. 4

Form BU (INF/B)
für bezahnte Unterkiefer, ungelocht
for toothed lower jaws, unperforated
Mandibules dentés, non perforés
para mandíbulas inferiores dentadas, no perforadas
per mascella inferiore dentata, non perforata

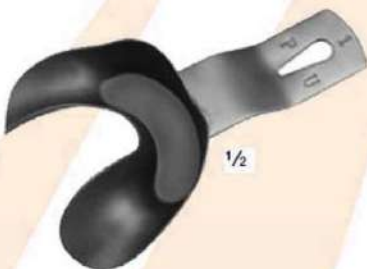

1/2

- 5161** = Fig. 1
- 5162** = Fig. 2

Form PU (INF/P)
für partiell bezahnte Unterkiefer, ungelocht
for partially toothed lower jaws, unperforated
Mandibules partiellement dentés, non perforés
para mandíbulas inferiores parcialmente dentadas, no perforadas
per mascella inferiore parzialmente dentata, non perforata

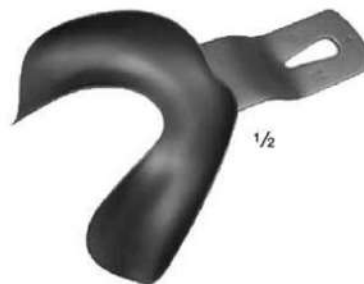

1/2

- 5171** = Fig. 1
- 5172** = Fig. 2

Form UO (INF/U)
für unbezahnte Unterkiefer, ungelocht
for edentulous lower jaws, unperforated
Mandibules édentés, non perforés
para mandíbulas inferiores desdentadas, no perforadas
per mascella inferiore edentula, non perforata



TUFFRO

The Mangalm Surgical Co.

Dental

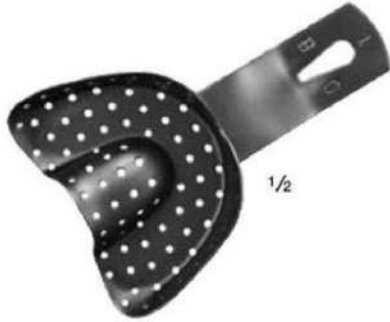

1/2

- 5201 = Fig. 1
- 5202 = Fig. 2
- 5203 = Fig. 3
- 5204 = Fig. 4

Form BO (SUP/B)
für bezahnte Oberkiefer, gelocht
for toothed upper jaws, perforated
Maxillaires dentés, perforés
para mandíbulas superiores dentadas, perforadas
per mascella superiore dentata, perforata

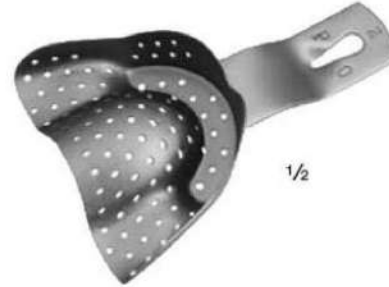

1/2

- 5221 = Fig. 1
- 5222 = Fig. 2

Form PO (SUP/P)
für partiell bezahnte Oberkiefer, gelocht
for partially toothed upper jaws, perforated
Maxillaires partiellement dentés, perforés
para mandíbulas superiores parcialmente dentadas, perforadas
per mascella superiore parzialmente dentata, perforata

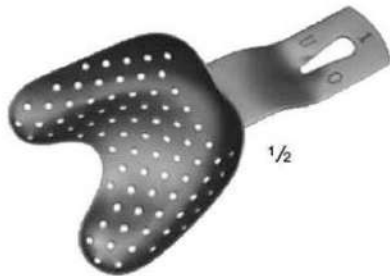

1/2

- 5231 = Fig. 1
- 5232 = Fig. 2
- 5233 = Fig. 3

Form UO (SUP/U)
für unbezahnte Oberkiefer, gelocht
for edentulous upper jaws, perforated
Maxillaires édentés, perforés
para mandíbulas superiores desdentadas, perforadas
per mascella superiore edentula, perforata



1/2

- 5251 = Fig. 1
- 5252 = Fig. 2
- 5253 = Fig. 3
- 5254 = Fig. 4

Form BU (INF/B)
für bezahnte Unterkiefer, gelocht
for toothed lower jaws, perforated
Mandibules dentés, perforés
para mandíbulas inferiores dentadas, perforadas
per mascella inferiore dentata, perforata

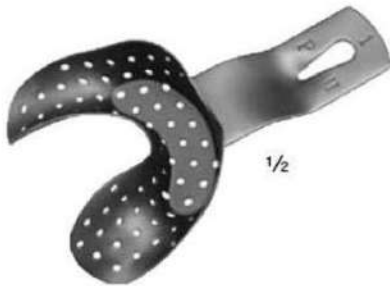

1/2

- 5261 = Fig. 1
- 5262 = Fig. 2

Form PU (INF/P)
für partiell bezahnte Unterkiefer, gelocht
for partially toothed lower jaws, perforated
Mandibules partiellement dentés, perforés
para mandíbulas inferiores parcialmente dentadas, perforadas
per mascella inferiore parzialmente dentata, perforata



1/2

- 5271 = Fig. 1
- 5272 = Fig. 2
- 5273 = Fig. 3

Form UO (INF/U)
für unbezahnte Unterkiefer, gelocht
for edentulous lower jaws, perforated
Mandibules édentés, perforés
para mandíbulas inferiores desdentadas, perforadas
per mascella inferiore edentula, perforata



TUFFRO

The Mangalm Surgical Co.

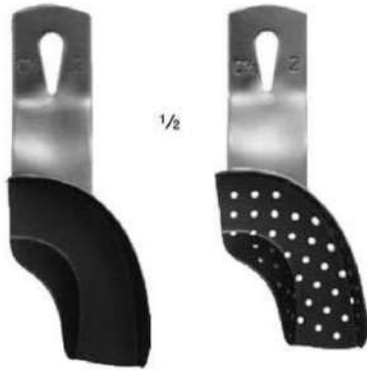

Form C1/2R

ungelocht
unperforated
non perforé
no perforadas
non perforata

5702 = Fig. 2

gelocht
perforated
perforé
perforadas
perforata

5722 = Fig. 2

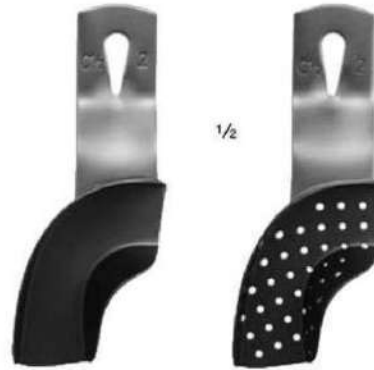

Form C1/2L

ungelocht
unperforated
non perforé
no perforadas
non perforata

5712 = Fig. 2

gelocht
perforated
perforé
perforadas
perforata

5732 = Fig. 2



Stolley
5760

mit drehbarem Griff und Fixierschieber, gelocht
with swivel handle and slide, perforated
avec poignée pivotante et curseur de fixation, perforé
con mango giratorio y cierre corredizo, perforadas
con impugnatura girevole e cursore di fissaggio, perforata



5751

mit drehbarem Griff und Stellschraube, gelocht
with swivel handle and fixing screw, perforated
avec poignée pivotante et vis de blocage, perforé
con mango giratorio y tornillo de sujeción, perforadas
con impugnatura girevole e vite di regolazione, perforata



5755

mit drehbarem Griff und Stellschraube, ungelocht
with swivel handle and fixing screw, unperforated
avec poignée pivotante et vis de blocage, non perforé
con mango giratorio y tornillo de sujeción, no perforadas
con impugnatura girevole e vite di regolazione, non perforata

Dental



TUFFRO

The Mangalm Surgical Co.

Dental

2 4 6 8 10 12



N 22 T
15 cm

3,5,5,5,8,5,11,5



WHO T
15 cm

3 6 9 12



N 33
15 cm

Rundgriff / massiv / gerieft
Round handle / solid / serrated
Manche rond / massive / striée
Mango redando / sólido / estriado
Manico tondo / solida / zigrinata



TUFFRO

The Mangalm Surgical Co.



1220/11
Whiteside 1
15,5 cm



39 R
15 cm



1200/3
15 cm



1200/4
15 cm



1280/2
Mitchell
17 cm



1200/3 P
16 cm



1280/63 P
Rheinwaldhäkchen
17 cm

Achtkantgriff / massiv / gerieft
Octagonal handle / solid / serrated
Manche octagonal / massive / striée
Mango octagonal / sólido / estriado
Manico ottagonale / solida / zigrinate

Hohigriff
Hollow Handle
Poignée creuse
Mango hueco
Manico cavo

Dental



TUFFRO

The Mangalm Surgical Co.

Dental



204 S Z
Universal
17,5 cm



CI 2-3 Z
16 cm



N5-U15 Z
16 cm



N 67 Z
17 cm



OR 1-2 Z
Orban #1-2
17 cm

Zahnreiniger
Scalers
Instruments à Détartrer
Limpiadores de Sarro
Ablatori di Tartaro

Neuer LIGHTWEIGHT Griff
New LIGHTWEIGHT handle
Neuf manche LIGHTWEIGHT
Nuevo mango LIGHTWEIGHT
Nuovo manico LIGHTWEIGHT

Gingivektomiemesser
Gingivectomy knives
Bistouris pour la gingivectomie
Bisturios para la gingivectomia
Bisturie per gengivectomia

Neuer LIGHTWEIGHT Griff
New LIGHTWEIGHT handle
Neuf manche LIGHTWEIGHT
Nuevo mango LIGHTWEIGHT
Nuovo manico LIGHTWEIGHT



TUFFRO

The Mangalm Surgical Co.



GR 1-2 Z

Gracey
#1-2
17,5 cm

Frontzähne, universell
Incisors universal
Incisivos, universal
Incisivi, universali

Neuer LIGHTWEIGHT Griff
New LIGHTWEIGHT handle
Neuf manche LIGHTWEIGHT
Nuevo mango LIGHTWEIGHT
Nuovo manico LIGHTWEIGHT



GR 3-4 Z

Gracey
#3-4
17 cm

Frontzähne, Prämolaren universell
Incisors, premolars universal
Incisivos, prémolaires universel
Incisivos, prémolares universal
Incisivi, premolari universali

Neuer LIGHTWEIGHT Griff
New LIGHTWEIGHT handle
Neuf manche LIGHTWEIGHT
Nuevo mango LIGHTWEIGHT
Nuovo manico LIGHTWEIGHT



GR 5-6 Z

Gracey
#5-6
17,5 cm

Frontzähne, Prämolaren universell
Incisors, premolars universal
Incisivos, prémolaires universel
Incisivos, prémolares universal
Incisivi, premolari universali

Neuer LIGHTWEIGHT Griff
New LIGHTWEIGHT handle
Neuf manche LIGHTWEIGHT
Nuevo mango LIGHTWEIGHT
Nuovo manico LIGHTWEIGHT



GR 7-8 Z

Gracey
#7-8
17,5 cm

Prämolaren, Molaren, lingual / bukkal
Premolars, molars, lingual / buccal
Prémolaires, molaires lingual, buccal
Premolares, molares, lingual / bucal
Premolari, molari, linguali / buccali

Neuer LIGHTWEIGHT Griff
New LIGHTWEIGHT handle
Neuf manche LIGHTWEIGHT
Nuevo mango LIGHTWEIGHT
Nuovo manico LIGHTWEIGHT

Dental



TUFFRO

The Mangalm Surgical Co.

Dental



586 WS
Witzel
14,5 cm

untere Wurzeln
lower roots
racines inférieures
raíces inferiores
radici inferiori



588 WS
Witzel
14,5 cm

obere Wurzeln
upper roots
racines supérieures
raíces superiores
radici superiori



TUFFRO

The Mangalm Surgical Co.

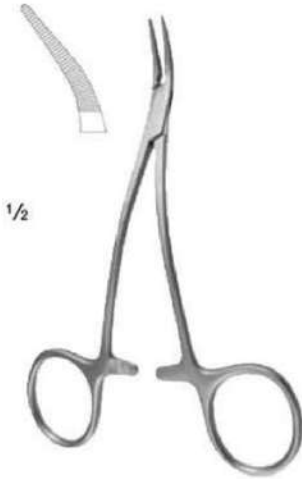

597
Peet
12 cm

Wurzelfragmente
Root fragments
Fragments de racines
Fragmentos de raices
Frammenti

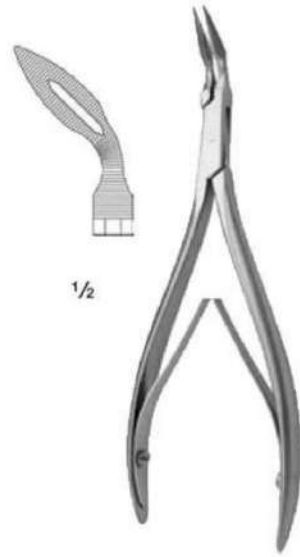

596/1
Raik
14 cm

Wurzelfragmente
Root fragments
Fragments de racines
Fragmentos de raices
Frammenti

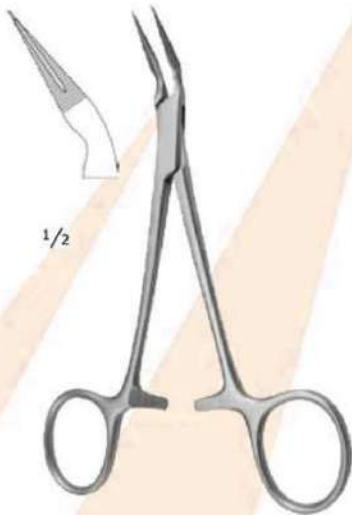

592
Stieglitz
13,5 cm

Wurzelfragmente
Root fragments
Fragments de racines
Fragmentos de raices
Frammenti

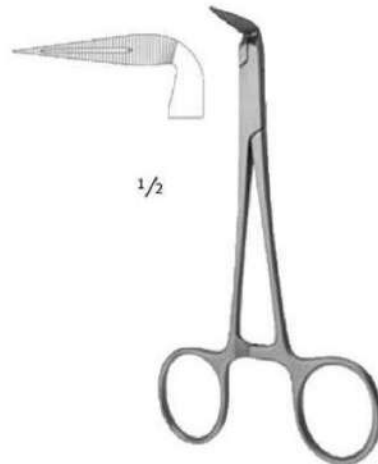

593
Stieglitz
12 cm

Wurzelfragmente
Root fragments
Fragments de racines
Fragmentos de raices
Frammenti

Dental



TUFFRO

The Mangalm Surgical Co.

Dental



2520/2
15 cm

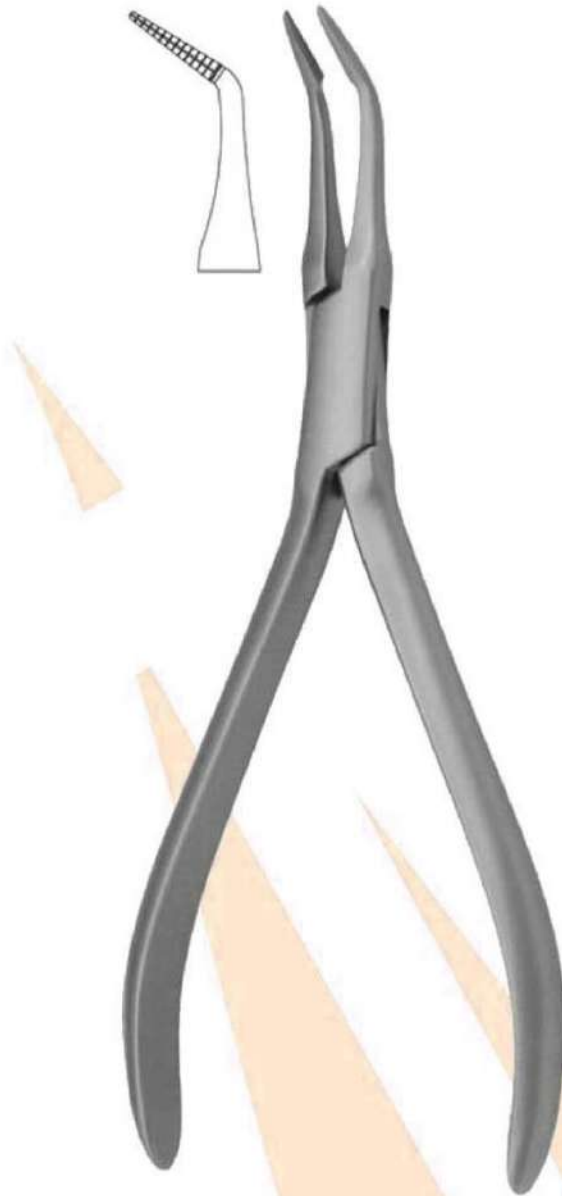

2520/5
15 cm



TUFFRO

The Mangalm Surgical Co.



885/3
Molt
18,5 cm

885/5
Molt # 9
18,5 cm

890/1
Freer
18,5 cm

902/41
19 cm

I/6
Implantologie
15,5 cm

O 24 GZ
17 cm

Rundgriff / massiv / gerieft
Round handle / solid / serrated
Manche rond / massive / striée
Mango redondo / sólido / estriado
Manico tondo / solida / zigrinata

Neuer LIGHTWEIGHT Griff
New LIGHTWEIGHT handle
Neuf manche LIGHTWEIGHT
Nuevo mango LIGHTWEIGHT
Nuovo manico LIGHTWEIGHT

Dental



TUFFRO

The Mangalm Surgical Co.

Dental



901/84
856
18 cm



901/85
854
18,5 cm



901/86
853
18 cm



901/89
Bennet # 12 S
18 cm



901/97
Albjerg
17,5 cm



901/98
Alley
21 cm

Rundgriff / massiv
Round handle / solid
Manche rond / massive
Mango redando / sólido
Manico tondo / solida



TUFFRO

The Mangalm Surgical Co.



888/23

18 cm



888/3

Cleve-Dent
19 cm



888/4

18 cm



888/94

Molt
19 cm



888/3A

9 H
17,5 cm

Achtkantgriff / massiv / gerieft
Octagonal handle / solid / serrated
Manche octagonal / massive / striée
Mango octagonal / sólido / estriado
Manico ottagonale / solida / zigrinate

Dental



TUFFRO

The Mangalm Surgical Co.

Dental



PA 19
16 cm



880/1
Williger
16 cm



910/5
Tessier
18 cm

Hohlgriff
Hollow handle
Poignée creuse
Mango hueco
Manico cavo



910/7
Tessier
18 cm

Hohlgriff
Hollow handle
Poignée creuse
Mango hueco
Manico cavo



910/9
Tessier
18 cm

Hohlgriff
Hollow handle
Poignée creuse
Mango hueco
Manico cavo



TUFFRO

The Mangalm Surgical Co.



901/24
Miller-Colburn
9
18 cm

901/25
Miller-Colburn
10
19 cm

901/26
Miller-Colburn
11
19 cm

901/27
Miller-Colburn
12
19 cm

901/28
Miller-Colburn
13
18,5 cm

901/35
Molt
18,5 cm

901/309
Terry
18,5 cm

Rundgriff / massiv
Round handle / solid
Manche rond / massive
Mango redando / sólido
Manico tondo / solida

Dental



TUFFRO

The Mangalm Surgical Co.

Dental



920-11
Lucas
1 R - 1 L
18 cm



920-22
Lucas
2 R - 2 L
18 cm



920-33
Lucas
3 R - 3 L
18 cm



920-44
Lucas
4 R - 4 L
18 cm



920-85
Lucas
17 cm



920-86
Lucas
17 cm

Achtkantgriff / massiv / gerieft
Octagonal handle / solid / serrated
Manche octagonal / massive / striée
Mango octagonal / sólido / estriado
Manico ottagonale / solida / zigrinate



TUFFRO

The Mangalm Surgical Co.

Dental



925/7
18 cm

925/8
18 cm

925/9
18 cm

Achtkantgriff / massiv / gerieft
Octagonal handle / solid / serrated
Manche octagonal / massive / striée
Mango octagonal / sólido / estriado
Manico ottagonale / solida / zigrinata



928/1
18,5 cm

928/2
19 cm

928/3
19 cm

Rundgriff / massiv / gerieft
Round handle / solid / serrated
Manche rond / massive / striée
Mango redondo / sólido / estriado
Manico tondo / solida / zigrinata



TUFFRO

The Mangalm Surgical Co.

Dental



926/30
Molt #5 L
18 cm

Hohigriff
Hollow handle
Poignée creuse
Mango hueco
Manico cavo



926/31
Molt #5 R
18 cm

Hohigriff
Hollow handle
Poignée creuse
Mango hueco
Manico cavo



926/32
Molt #4
16,5 cm

Hohigriff
Hollow handle
Poignée creuse
Mango hueco
Manico cavo



926/33
Molt #2
17 cm

Hohigriff
Hollow handle
Poignée creuse
Mango hueco
Manico cavo



926/34
Molt #1
17 cm

Hohigriff
Hollow handle
Poignée creuse
Mango hueco
Manico cavo



TUFFRO

The Mangalm Surgical Co.



930/0
Hemingway
2,6 / 2,6 mm
16,5 cm



930/4
Hemingway
2,8 / 2,8 mm
16,5 cm



930/5
Hemingway
3,2 / 3,2 mm
16,5 cm



930/6
Hemingway
3,8 / 3,8 mm
16,5 cm

Achtkantgriff / massiv / gerieft
Octagonal handle / solid / serrated
Manche octogonale / massive / striée
Mango octagonal / sólido / estriado
Manico ottagonale / solida / zigrinate

Dental



TUFFRO

The Mangalm Surgical Co.

Dental



932/9 R
2,7 / 2,7 mm
17 cm



932/9 AR
2,7 / 2,7 mm
17 cm



932/10 R
3,2 / 3,2 mm
17 cm



932/10 AR
3,2 / 3,2 mm
17 cm



932/11 R
3,8 / 3,8 mm
17 cm



932/11 AR
3,8 / 3,8 mm
17 cm

Rundgriff / massiv / gerieft
Round handle / solid / serrated
Manche rond / massive / striée
Mango redando / sólido / estriado
Manico tondo / solida / zigrinate



TUFFRO

The Mangalm Surgical Co.

Dental



1/2

966
Mueller
8 cm

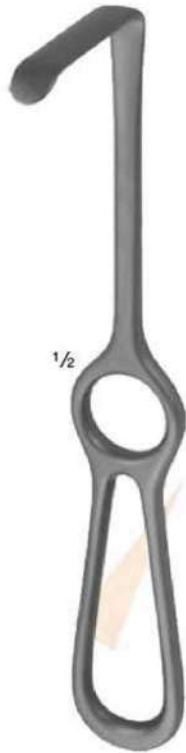

1/2

968/1
56 x 11 mm
Kocher
20,5 cm

968/2
40 x 11 mm
Kocher
20,5 cm

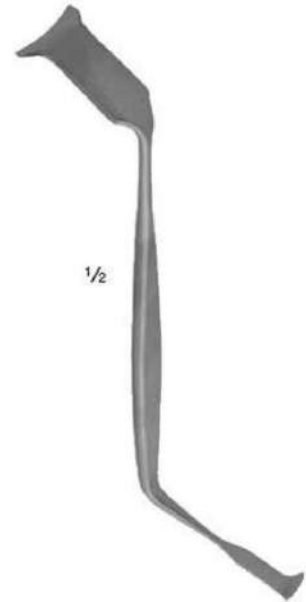

1/2

980/5
16,5 cm



1/2

998/13
Farabeuf
12,5 cm



1/2

998/20
University of Minnesota
15,5 cm

Zungendrucker
Tongue depressor
Abaisse-langue
Depresor de lingua
Abbassalingua



999/21
Wieder
14 cm



999/22
Wieder
16 cm

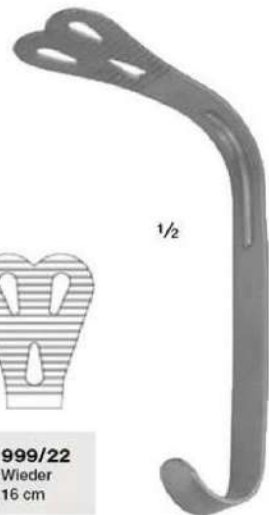

1/2



TUFFRO

The Mangalm Surgical Co.

Dental

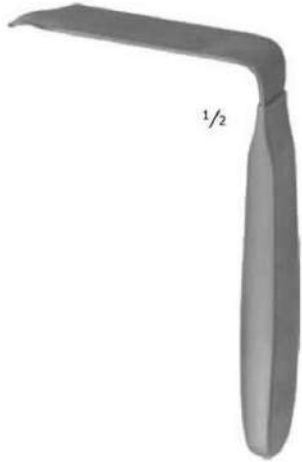

1/2

999/1
Austin
13 cm



1/2

999/4
Catania
15,5 cm



1/2

999/5
Ronnau
15,5 cm

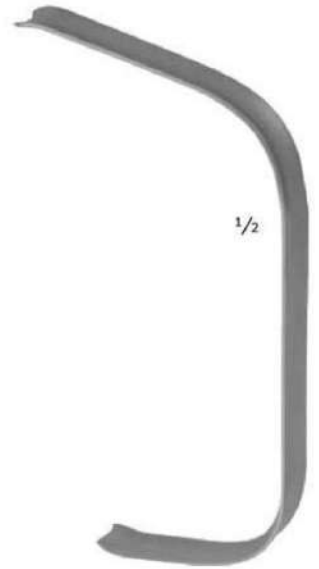

1/2

999/6
16 cm



1/2

999/3
Austin
#2
8 cm



1/2

999/3 B
8,5 cm



1/2

999/97
Austin
#3
11,5 cm



TUFFRO

The Mangalm Surgical Co.



Rundgriff / massiv
Round handle / solid
Manche rond / massive
Mango redando / sólido
Manico tondo / solida

901/78
Henahan
1 - 2
21 cm

901/79
Henahan
1 - 3
21 cm

901/80
Henahan
2 - 3
21 cm



926/84
Henahan
1
17,5 cm

926/85
Henahan
2
18 cm

926/86
Henahan
3
18,5 cm

Hohlgriff
Hollow handle
Poignée creuse
Mango hueco
Manico cavo

Hohlgriff
Hollow handle
Poignée creuse
Mango hueco
Manico cavo

Hohlgriff
Hollow handle
Poignée creuse
Mango hueco
Manico cavo

Dental



TUFFRO

The Mangalm Surgical Co.

Dental

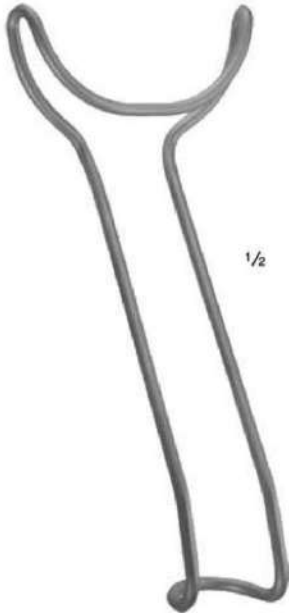

1/2

967/1
18 cm



1/2

1005/12
Sternberg
12 cm

1005/14
Sternberg
14 cm

1005/16
Sternberg
16 cm



1/2

1115/11
Molt
11 cm

1115
for 1115/11 &
1115/14
1 Paar Schutzhüllen
1 pair of protective covers
1 paire enveloppe protectrice
1 pareja cubierta protectora
1 coppia custodia



1/2

1115/14
Molt
14 cm



1/2

1122
Denhart
13 cm

1122 E
for 1122

1 Paar Silikoneinlage
1 pair of silicon inserts
1 paire de protecteurs silicones
1 pareja de silicon capas
1 coppia di inserti del silicone



TUFFRO

The Mangalm Surgical Co.



2320/2
London-College
15 cm

gerieft, mit Sperre
serrated, with lock
striée, avec cierre
estriada, con cierre
zigrinata, con fermo



2325/1
London-College
15 cm

für Silberspitzen, mit Sperre
for silver points, with lock
pour cones d'argent, avec cierre
para puntas de plata, con cierre
per punte d'argento, con fermo



2325/2
London-College
15 cm

für Silberspitzen, mit Sperre
for silver points, with lock
pour cones d'argent, avec cierre
para puntas de plata, con cierre
per punte d'argento, con fermo



2265 D
Meriam
16 cm



diamantierte Spitzen
diamonded tips
pointes diamantées
puntas diamantadas
punte diamantate

Dental



TUFFRO

The Mangalm Surgical Co.

Dental



2379

13,5 cm

Hohlgriff
Hollow handle
Poignée creuse
Mango hueco
Manico cavo



2379-3

1

o 3,0 mm

4,5 cm

2379-5

2

o 5,0 mm

4,5 cm

2379-6

3

□ 3 x 6 mm

4,5 cm

Rhodium-Mikrospiegelansatz in rodio für höchste Ansprüche unterm Mikroskop
Rhodium- micro mirror for highest requirements under the microscope
Micro-miroir au rhodium pour des exigences extremes sous le microscope
Microespejo de rodio para las más altas exigencias bajo el microscopio
Microspecchio metallico per i massimi requisiti al microscopio

für Wurzelspitzenresektion, passend für jeden Spiegelgriff, metr. Gewinde
for apicoectomy, suitable for any mirror handle, metr. thread
pour, résection de l'apex de la racine, adapté à chaque poignée de miroir, filetage métrique
para la apicectomia, apropiado para cualquier mango de espejo, rosca métrica
per apicectomia, appropriato a ogni tipo di impugnatura di specchio, filettatura metrica



TUFFRO

The Mangalm Surgical Co.



611
14 cm



611 F
14 cm



611 S
14 cm

Dental



TUFFRO

The Mangalm Surgical Co.

Dental

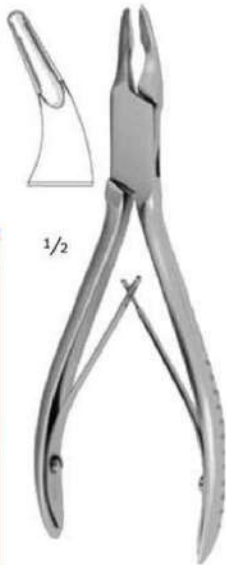

825/1
Blumenthal
15,5 cm

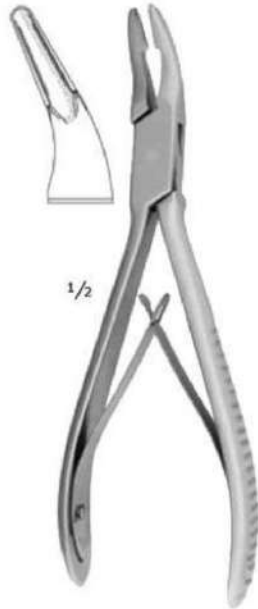

825/8
Mead 1 A
16,5 cm

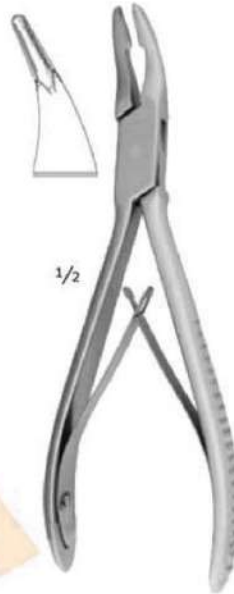

825/8 S
16,5 cm

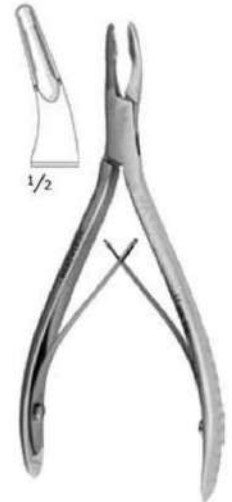

825/10
Friedman
13,5 cm

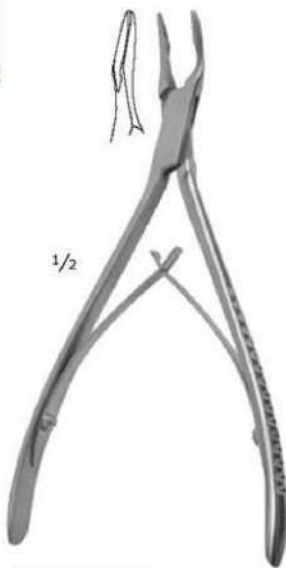

825/10 M
Micro-Friedman
15,5 cm

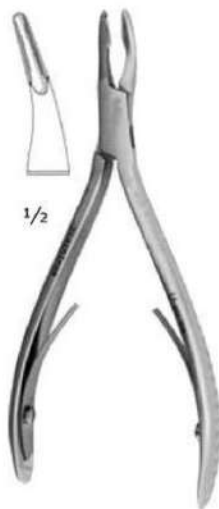

825/10 S
Friedman-Vickers
14 cm

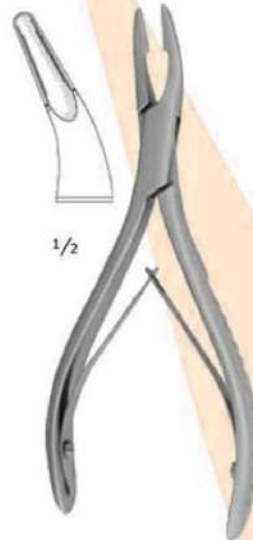

825/11
Luer
15 cm

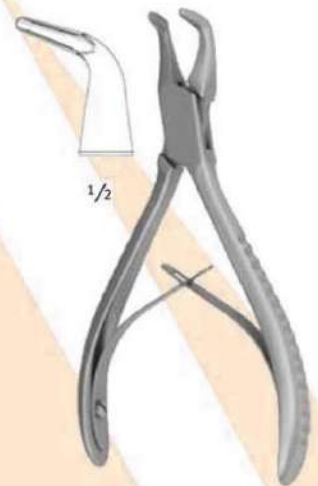

825/20
13,5 cm



TUFFRO

The Mangalm Surgical Co.

Dental



1/2

830/404
4 mm
17 cm



1/2

830/405
4 mm
17,5 cm

Rundgriff / massiv
Round handle / solid
Manche rond / massive
Mango redondo / sólido
Manico tondo / solida



1/2

831/399
Stout #1
3 mm
21,5 cm



1/2

831/400
Stout #2
4 mm
21 cm



1/2

831/401
Stout #3
5 mm
22 cm



1/2

850/402
4 mm
18 cm

Achtkantgriff / massiv / gerieft
Octagonal handle / solid / serrated
Manche octagonal / massive / striée
Mango octagonal / sólido / estriado
Manico ottagonale / solida / zigrinate



TUFFRO

The Mangalm Surgical Co.

Dental



1/2

860/2
140 g
16,5 cm

bleigefüllt
lead filled
rempli de plomb
relleno de plomo
interno piombo



1/2

860/5
180 g
18 cm

PE 860/5

Hohlgriff / auswechselbare Kunststoffeinsätze Art No. PE 860 / 5
Hollow handle / interchangeable plastic inserts Art No. PE 860 / 5
Poignée creuse / plaques interchangeables en matériel plastique Art No. PE 860 / 5
Mango hueco / tapas de plástico intercambiables Art No. PE 860 / 5
Manico cavo / inserti plastica intercambiabili Art No. PE 860 / 5



1/2

860/4
Mead
19 cm
320 g

860/4E

Auswechselbare Kunststoffeinsätze Art No. 860 / 4 E
Interchangeable plastic inserts Art No. 860 / 4 E
Plaques interchangeables en matériel plastique Art No. 860 / 4 E
Tapas de plástico intercambiables Art No. 860 / 4 E
Inserti plastica intercambiabili Art No. 860 / 4 E



TUFFRO

The Mangalm Surgical Co.

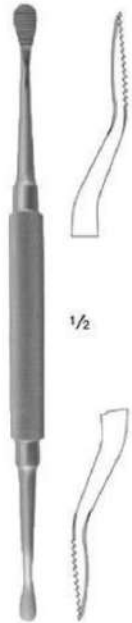

865 / 201
Howard
12
18,5 cm
Rundgriff / massiv / gerieft
Round handle / solid / serrated
Manche rond / massive / striée
Mango redondo / sólido / estriado
Manico tondo / solida / zigrinata

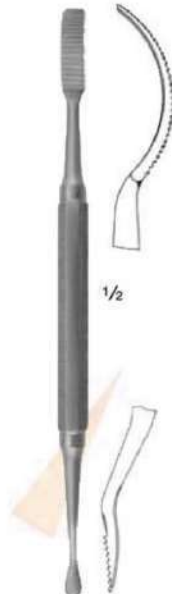

875 / 3
Miller-Colburn
#3
17,5 cm

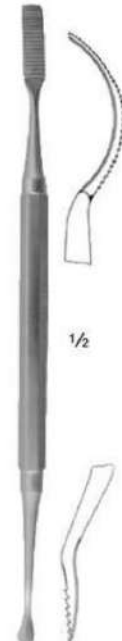

875/29
Miller
#52
19 cm
Achtkantgriff / massiv / gerieft
Octagonal handle / solid / serrated
Manche octagonal / massive / striée
Mango octagonal / sólido / estriado
Manico ottagonale / solida / zigrinata

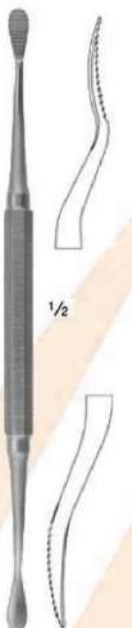

875/1
18,5 cm

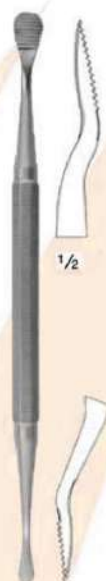

875 / 12
Miller-Colburn #1
17 cm



875/2 K
18 cm



875/8
Miller-Colburn #1
18,5 cm

Achtkantgriff / massiv / gerieft
Octagonal handle / solid / serrated
Manche octagonal / massive / striée
Mango octagonal / sólido / estriado
Manico ottagonale / solida / zigrinata

Dental



TUFFRO

The Mangalm Surgical Co.

Dental

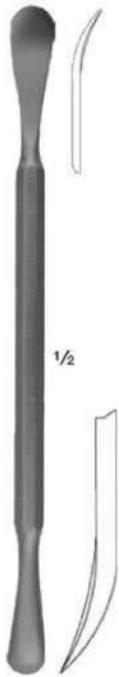

896/23
Seldin
19 cm
Achtkantgriff / massiv / gerieft
Octagonal handle / solid / serrated
Manche octagonal / massive / striée
Mango octagonal / sólido / estriado
Manico ottagonale / solida / zigrinate

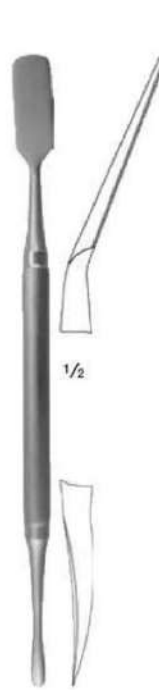

880/6 B
18 cm

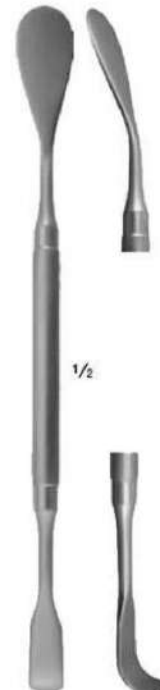

890 / 11
Orbita-Haken
19,5 cm

Rundgriff / massiv
Round handle / solid
Manche rond / massive
Mango redondo / sólido
Manico tondo / solida

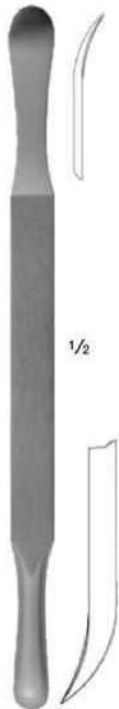

895/23
Seldin
20 cm

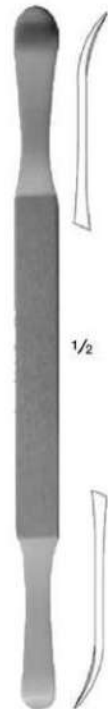

895/23 D
Seldin
20 cm

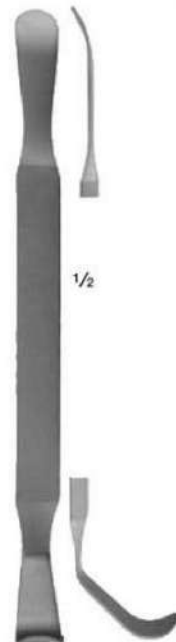

895/26
18 cm
massiv
solid
massive
sólido
solida



TUFFRO

The Mangalm Surgical Co.

Dental



1030/1
Allis
16 cm

Zahnfleischfzasszangen
Gum seizing forceps
Pince à gencive
Pinze para filar la encla
Pinze per gengive



1030/2
Allis
15 cm



1030/3
Allis
15 cm

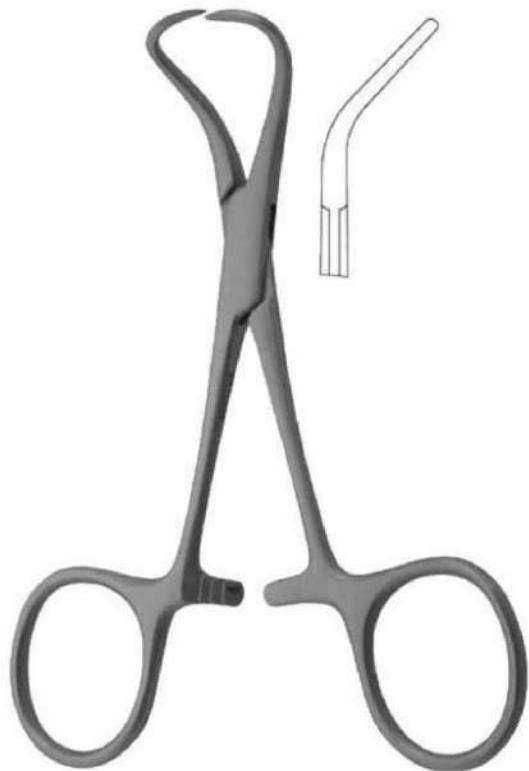

1065
Backhaus
11 cm

Tuchklemme
Towel clip
Pince à champs
Pinza de campo
Pinze per pannolino



TUFFRO

The Mangalm Surgical Co.

Dental

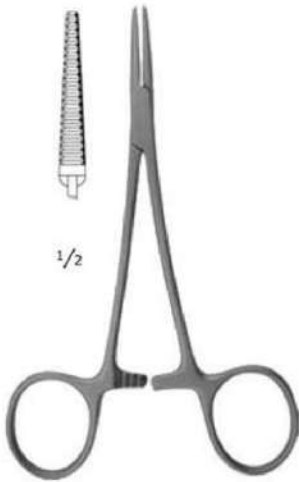

1/2

1050/1
Halstead-
Mosquito
12,5 cm



1050/2
Halstead-
Mosquito
12,5 cm

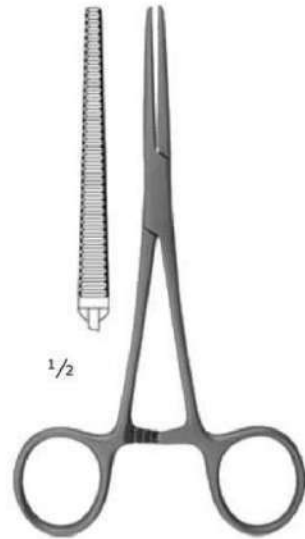

1/2

1055/1
Pean
14 cm



1055/2
Pean
14 cm

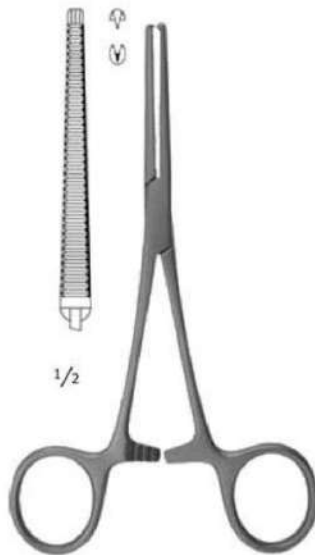

1/2

1060/1
Kocher
14 cm



1060/2
Kocher
14 cm



TUFFRO

The Mangalm Surgical Co.



1070/15
Mayo-Hegar
15 cm

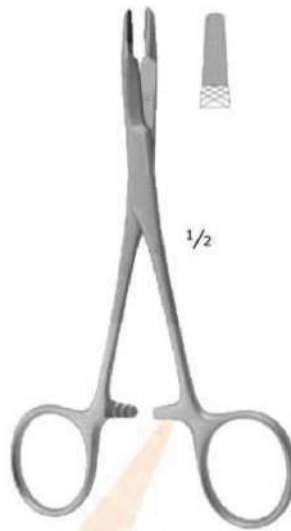

1084/14 TC
Olsen-Hegar
14 cm

TC =
Hartmetalleinsätze
Tungsten carbide inserts
Pointes en tungstène
Puntas de tungsteno
Punte al carburo di tungsteno

1084/17 TC
Olsen-Hegar
17 cm



1097 TC
Mayo-Hegar
16 cm

TC =
Hartmetalleinsätze
Tungsten carbide inserts
Pointes en tungstène
Puntas de tungsteno
Punte al carburo di tungsteno



1099/13 TC
Halsey
13 cm

TC =
Hartmetalleinsätze
Tungsten carbide inserts
Pointes en tungstène
Puntas de tungsteno
Punte al carburo di tungsteno

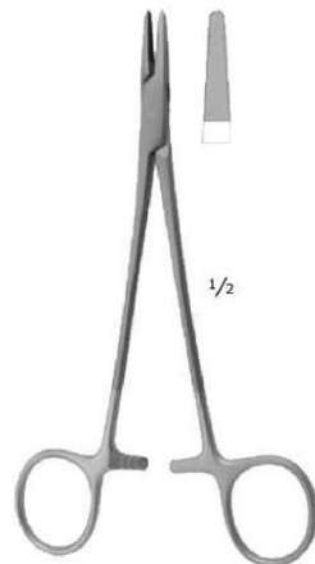

1099/15 TC
Crile-Wood
15 cm

TC =
Hartmetalleinsätze
Tungsten carbide inserts
Pointes en tungstène
Puntas de tungsteno
Punte al carburo di tungsteno

1099/18 TC
Crile-Wood
18 cm

Dental



TUFFRO

The Mangalm Surgical Co.

Dental

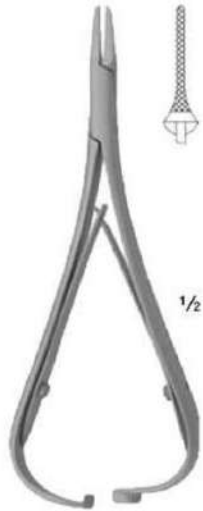

1076/14
Mathieu
14 cm

1076/17
Mathieu
17 cm



1093/14 TC
Mathieu
14 cm

1093/17 TC
Mathieu
17 cm

TC =
Hartmetalleinsätze
Tungsten carbide inserts
Pointes en tungstène
Puntas de tungsteno
Punte al carburo di tungsteno

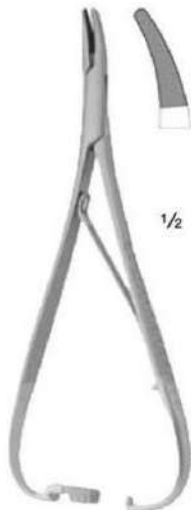

1094/14 TC
Mathieu-Metzenbaum
14 cm

1094/17 TC
Mathieu-Metzenbaum
17 cm

TC =
Hartmetalleinsätze
Tungsten carbide inserts
Pointes en tungstène
Puntas de tungsteno
Punte al carburo di tungsteno

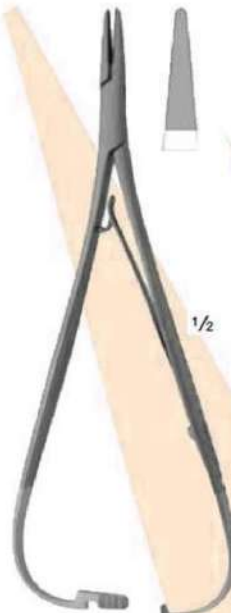

1098 TC
Lichtenberg
17 cm

1098 1 TC
Lichtenberg
17 cm

TC =
Hartmetalleinsätze
Tungsten carbide inserts
Pointes en tungstène
Puntas de tungsteno
Punte al carburo di tungsteno

gebogen
curved
courbées
curvas
curve



TUFFRO

The Mangalm Surgical Co.



1096 TC
Castroviejo
14 cm

1096/1 TC
Castroviejo
18 cm

TC =
Hartmetalleinsätze
Tungsten carbide inserts
Pointes en tungstène
Puntas de tungsteno
Punte al carburo di tungsteno



1096/2 TC
Castroviejo
14 cm

1096/3 TC
Castroviejo
18 cm

TC =
Hartmetalleinsätze
Tungsten carbide inserts
Pointes en tungstène
Puntas de tungsteno
Punte al carburo di tungsteno



1096/5 TC
Barraquer
14 cm

1096/6 TC
Barraquer
18 cm

TC =
Hartmetalleinsätze
Tungsten carbide inserts
Pointes en tungstène
Puntas de tungsteno
Punte al carburo di tungsteno

Dental



TUFFRO

The Mangalm Surgical Co.



1145/110
4,1 cm



1145/111
4,3 cm



1145/112
3,8 cm



1145/113
4,2 cm



1145/115
4 cm

Skalpelklingen / sterili
Scalpel blades / sterile
Lames de bistouris / stériles
Hojas de bisturios / estériles
Lame per bisturi / sterili

einzel verpackt / Packung mit 100 Stück
single packed / package with 100 units
enveloppe individuelle / boîte de 100 lames
envase individual / paquete con 100 unidades
bustina individuale / scatola di 100 lame

Dental



1145/3
#3
13 cm



1151/1 A
14,5 cm



1145/7
#7
16 cm



1151/1
16 cm



1151/2
16 cm

abgewinkelt
angled
coudé
acodadas
angolato



1152
Screwable
15,5 cm



TUFFRO

The Mangalm Surgical Co.



Mikro-Scalpellklingen / steril
Micro scalpel blades / sterile
Micro lames de bistouris / stérile
Micro hojas de bisturios / estériles
Micro lame per bisturi / sterili
einzeln verpackt / Packung mit 10 Stück
single packed / package with 10 units
enveloppe individuelle / boîte de 10 lames
envase individual / paquete con 10 unidades
bustina individuale / scatola di 10 lame

1145/64
3 cm

1145/65
3,2 cm

1145/67
3,2 cm

1145/69
3 cm

beidseitig schneidend
two cutting edges
tranchant de deux côtés
corte de dos lados
rovesciabile graffiante



1145/3 KL
13 cm

Halter für Mikro-Scalpellklingen
Holder for micro blades
Manche pour micro lames
Mango para micro hojas
Manico per micro lamette



1136/1
15,5 cm

Zahnfleischmesser
Gum Knives
Couteau à gencives
Bisturios para encias
Coltelli per gengive



1136/2
15 cm

Dental



TUFFRO

The Mangalm Surgical Co.

Dental

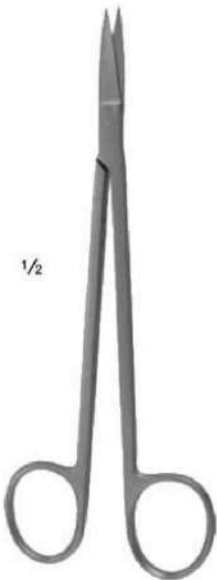

1/2

1153/1
Kelly
16 cm / 6 1/4"
gerade
straight
droits
rectas
diritte

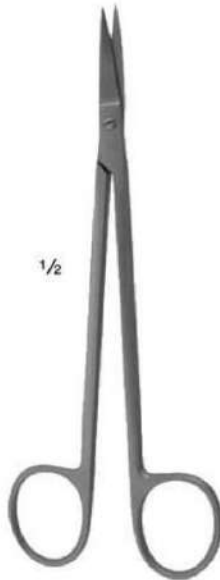

1/2

1153/2
Kelly
16 cm
gebogen
curved
courbés
curvatura
curve

1153/20
Kelly „Super Cut“
16 cm



1/2

1155/1
Iris
11 cm
gerade
straight
droits
rectas
diritte

1155/10
Iris „Super Cut“
11 cm



1/2

1155/2
Iris
11 cm
gebogen
curved
courbés
curvatura
curve

1155/20
Iris „Super Cut“
11 cm

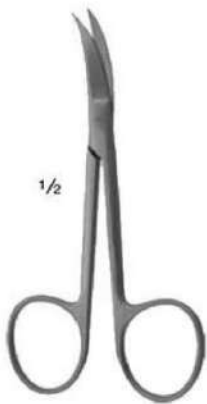

1/2

1155/3
Iris
11 cm



1/2

1158/1
Iris „Wolfram-Carbid“
11,5 cm / 4 1/2"
gerade
straight
droits
rectas
diritte

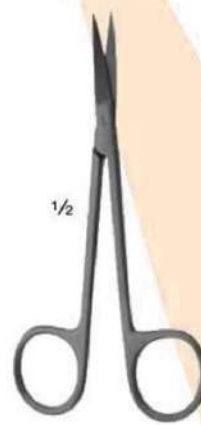

1/2

1158/2
Iris „Wolfram-Carbid“
11,5 cm / 4 1/2"

gebogen
curved
courbés
curvatura
curve



1/2

1158/4
Iris „Wolfram-Carbid“
11,5 cm / 4 1/2"



TUFFRO

The Mangalm Surgical Co.

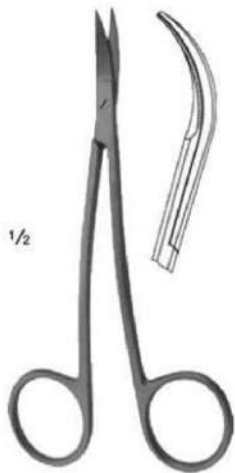

1/2

1154/1
La Grange
11,5 cm

S-gebogen
S-curved
S-courbés
curvatura S
curva a S



1/2

1155/6
Metzenbaum
15 cm

gebogen
curved
courbés
curvatura
curve



1/2

1161 TC
Federschloßschar
13 cm

gebogen
curved
courbés
curvatura
curve

TC =
Hartmetalleinsätze
Tungsten carbide inserts
Pointes en tungstène
Puntas de tungsteno
Punte al carburo di tungsteno

1154/10
La Grange „Super Cut“
11,5 cm



1/2

1162
Neumann
12 cm



1/2

1165/1
Goldman-Fox
13 cm

gezahnt
saw edge
dentelés
dentadas
dentate

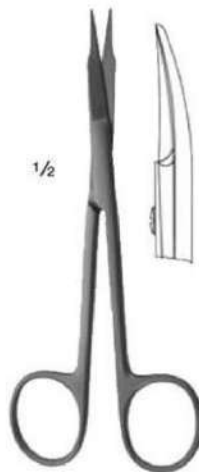

1/2

1165/2
Goldman-Fox
13 cm

gebogen
curved
courbés
curvatura
curve

gezahnt
saw edge
dentelés
dentadas
dentate



1/2

1166/2
Goldman-Fox
„Wolfram-Carbid“
13 cm

gebogen
curved
courbés
curvatura
curve

Dental



TUFFRO

The Mangalm Surgical Co.

Dental

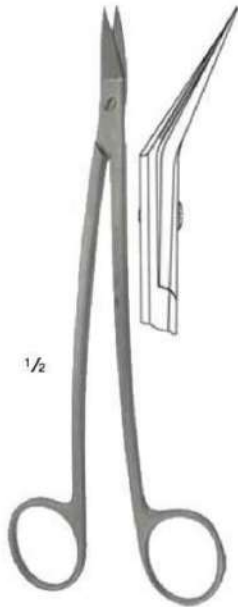

1/2

1172
Dean
17 cm

gezahnt
saw edge
dentelés
dentadas
dentate



1/2

1173
Locklin
„Wofram-Carbid“
16 cm



1/2

1168
11,5 cm

gebogen
curved
courbés
curvatura
curve



1/2

1178
12 cm

stumpi-spitz
blunt-pointed
mousse-pointu
romo-agudo
smusso-appuntato

gerade
straight
droits
rectas
dritte

1169

„Wofram-Carbid“
11,5 cm



1/2

1170
Micro-Scissor
12 cm

gebogen
curved
courbés
curvatura
curve



1/2

1170/5
Micro-Scissor
15 cm

gebogen
curved
courbés
curvatura
curve

1170 / 1
Micro-Scissor
14,5 cm



TUFFRO

The Mangalm Surgical Co.



1191/1
9 cm

gebogen
curved
courbés
curvatura
curve

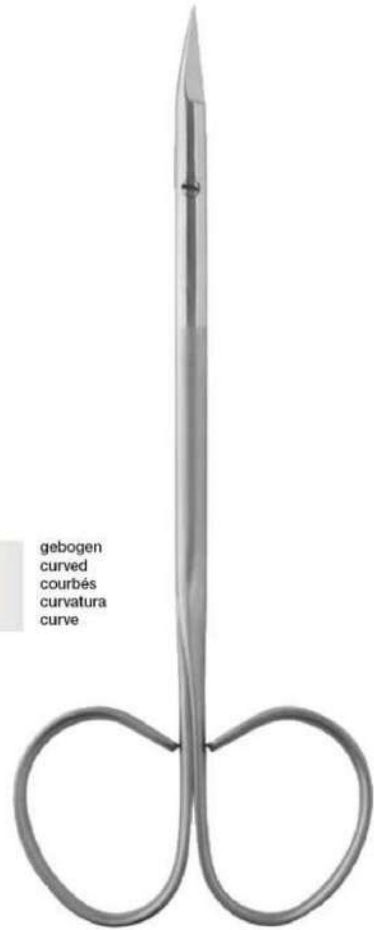

1191/2
13 cm

gebogen
curved
courbés
curvatura
curve

Dental



1190/1
Spencer
9 cm

PA 20
Spencer
11 cm

1190 / 2
Spencer
13 cm



PA 21
Spencer
11 cm



TUFFRO

The Mangalm Surgical Co.

Dental



PA 18
13 cm



2302/1
14,5 cm



PA 17
16 cm



PA 25
17 cm



TUFFRO

The Mangalm Surgical Co.



2310

18 cm

Anatomische Pinzette
Dressing Forceps
Pince à dissection
Pinza de disección
Pinze per dissezione



2315/3

16 cm
ø 1,6 mm

Naht- und Membranpinzette
Suture and membrane forceps
Pincettes à suture et à membrane
Pinzas para suturas y membranas
Pinzette per membrana e sutura



2315/4

15,5 cm
ø 2,2 mm



2330/1

16 cm
DeBakey 2,0 mm

Gefäßpinzetten / Atrauma
Vascular Forceps / Atrauma
Pincettes à dissection vasculaires / Atrauma
Pinzas de disección vascular / Atrauma
Pinze per dissezione vascolari / Atrauma



2330/2

15,5 cm
DeBakey 2,0 mm

Dental



TUFFRO

The Mangalm Surgical Co.

Dental



2655
1,8 cc
14 cm

Zylinder-Ampullen-Spritze
Cartridge syringes
Seringues d'ampoules
Jeringas de ampollas
Seringhe per tubofiale

mit Aspiration
with aspiration device
avec aspiration
con aspiración
con aspirazione

mit metrischem Gewinde
with metric thread
avec filetage métrique
con rosca métrica
con filettatura metrica



2659
1,8 cc
14 cm

Zylinder-Ampullen-Spritze
Cartridge syringes
Seringues d'ampoules
Jeringas de ampollas
Seringhe per tubofiale

mit Aspiration
with aspiration device
avec aspiration
con aspiración
con aspirazione

mit metrischem Gewinde
with metric thread
avec filetage métrique
con rosca métrica
con filettatura metrica



2666
1,8 cc
12,5 cm

Zylinder-Ampullen-Spritze
Cartridge syringes
Seringues d'ampoules
Jeringas de ampollas
Seringhe per tubofiale

ohne Aspiration
without aspiration device
sans aspiration
sin aspiración
senza aspirazione

mit metrischem Gewinde
with metric thread
avec filetage métrique
con rosca métrica
con filettatura metrica



TUFFRO

The Mangalm Surgical Co.



Ganzmetall Wasserspritze
All metal water syringe
Seringue à eau entièrement métallique
Jeringas para agua, de metal
Siringa per acqua interamente metallica

2665
10 cc
21 cm

selbstfüllend
self filling
autoremplissant
para relleno automático
riempire automatico



Druckspritze
Pressure syringe
Seringue à pression
Jeringa de presión

zur intra-ligamentalen Anästhesie, verwendbar mit Zylinder Ampullen 1,8 cc
for intra-ligamental anesthesia, for use with cartridges of 1,8 cc
pour l'anesthésie intra-ligamentaire, pour usage avec des ampoules de 1,8 cc
para la anestesia intra-ligamentaria, para uso con ampollas de 1,8 cc

2663
1,8 cc
b= 15 cm x h = 9,5 cm

Dental



TUFFRO

The Mangalm Surgical Co.

Dental

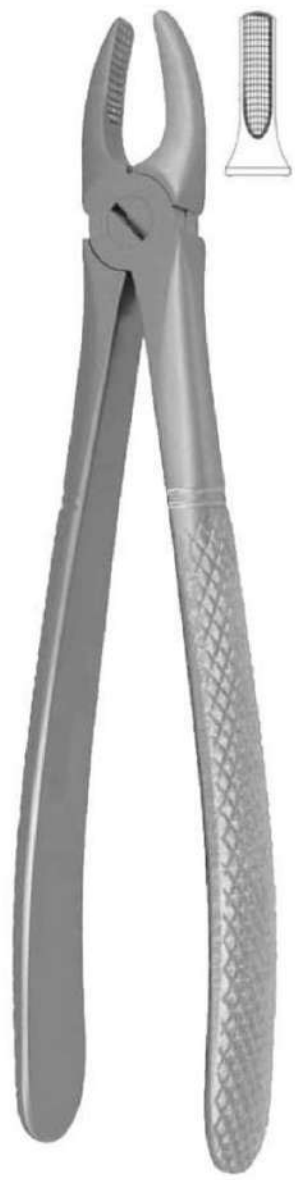

400/1 H
1
16 cm

400/1 D
1
16 cm

Schneide- und Eckzähne
Incisors and cuspids
Incisives et canines
Incisivos y caninos
Denti incisivi medi e denti canini



400/2 H
2
16 cm

400/2 D
2
16 cm

Seitliche Schneidezähne und Prämolaren
Incisors and bicuspid
Incisives et prémolaires
Incisivos y premolares
Denti incisivi laterali e denti premolari



400/7 H
7
16 cm

400/7 D
7
16 cm

Prämolaren
Bicuspid
Prémolaires
Premolares
Denti premolari



400/17 H
17
16 cm

400/17 D
17
16 cm

Molaren, rechts
Molars, right
Molaires, droit
Molares, derecho
Denti molari, destra



400/18 H
18
16 cm

400/18 D
18
16 cm

Molaren, links
Molars, left
Molaires, gauche
Molares, izquierdo
Denti molari, sinistra



TUFFRO

The Mangalm Surgical Co.



400/29 H
29
16 cm

400/29 D
29
16 cm



Wurzeln
Roots
Racines
Raices
Radici

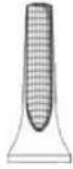

400/51 AH
51 A
16 cm

400/51 AD
51 A
16 cm



Wurzeln
Roots
Racines
Raices
Radici

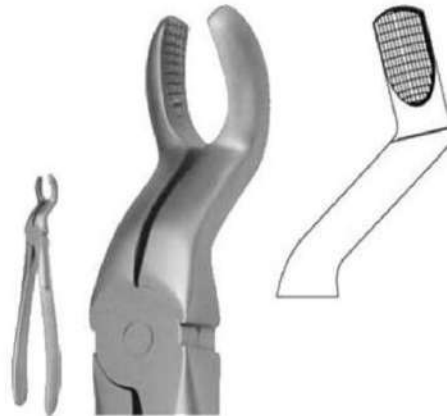

400/67 H
67
16 cm

400/67 D
67
16 cm



Dritte Molaren
Third molars
Troisièmes molaires
Terceros molares
Denti del giudizio



Dental



TUFFRO

The Mangalm Surgical Co.

Dental



400/13 H
13
14,5 cm

400/13 D 
13
14,5 cm

Prämolaren
Biscuspids
Prémolaires
Premolares
Denti premolari



400/22 H
22
14,5 cm

400/22 D 
22
14,5 cm

Molaren
Molars
Molaires
Molares
Denti molari



400/33 AH
33A
14,5 cm

400/33 AD 
33A
14,5 cm

Wurzeln
Roots
Racines
Raíces
Radici



400/73 D 
73
14,5 cm

Molaren
Molars
Molaires
Molares
Denti molari



TUFFRO

The Mangalm Surgical Co.



400/74 D
74
14,5 cm



Schneidezähne und Wurzeln
Incisors and roots
Incisives et racines
Incisivos y raíces
Denti incisivi e radici



400/74 NH
74 N
14,5 cm

400/74 ND
74 N
14,5 cm



Schneidezähne und Wurzeln, schlankes Maul
Incisors and roots, with fine beak
Incisives et racines, avec un bec très fin
Incisivos y raíces, con pico delgado
Denti incisivi e radici, morso delicato



400/79 H
79
16 cm

400/79 D
79
16 cm



Dritte Molaren
Third molars
Troisièmes molaires
Terceros molares
Denti del giudizio

Dental



TUFFRO

The Mangalm Surgical Co.



720/12 B
12 B Krogh
15,5 cm



720/6
Seldin # 34 S
15,5 cm



720/7
Seldin # 34
15,5 cm



720/12
Seldin # 3
15,5 cm



720/15
Seldin # 2
16 cm



720/21
Seldin # 1 L
16 cm



720/22
Seldin # 1 R
16 cm



720/23
Seldin # 4 L
16 cm



720/24
Seldin # 4 R
16 cm



720/10
Flohr
15,5 cm



720/11
Flohr
15,5 cm



720/290
Apical Flohr
4
15,5 cm



720/291
Apical Flohr
5
15,5 cm



720/293
Apical Flohr
81
15,5 cm



720/303
Apical Flohr
46
15 cm

Dental



TUFFRO

The Mangalm Surgical Co.

Dental



720/16
12
15 cm



720/33
Miller # 1
15,5 cm



720/34
Miller # 2
15,5 cm



720/35
Miller # 3
15 cm



720/36
Miller # 4
15 cm



720/73 A
Miller # 73
15 cm



720/74 A
Miller # 74
15 cm



720/63
Cogswell # A
15 cm



720/64
Cogswell # B
15 cm



720/73 B
15 cm



720/74 B
15 cm



720/295
University of
Alabama
15 cm



720/300
Cameron
15,5 cm



720/77 R
Glogoff
15,5 cm



720/251
Lindo-Lovien
15 cm



TUFFRO

The Mangalm Surgical Co.



720/14
#3 A Cryer
15,5 cm



720/27
27 Cryer
16 cm



720/28
28 Cryer
16 cm



720/27 S
27 S Cryer
16 cm



720/28 S
28 S Cryer
16 cm



720/284
1 Cryer
15 cm



720/285
2 Cryer
15 cm



720/286
31 Cryer
15 cm



720/287
32 Cryer
15 cm



720/288
39 Cryer
15,5 cm



720/289
40 Cryer
15,5 cm



720/280
15 cm



720/281
15 cm



720/305
71
15,5 cm



720/306
72
15,5 cm

Dental



TUFFRO

The Mangalm Surgical Co.

Dental



720/34 SA
15 cm



720/46
15 cm



720/46 R
15 cm



720/57
14,5 cm



720/58
0
15 cm



720/59
1
15 cm



720/61
15 cm



720/80
15 cm



720/97
15 cm



720/98
15 cm



720/100
16 cm



720/252
46 R
15 cm

gerieft
serrated
striée
estriado
ziggrinate



720/266
11 A
15 cm



720/313
77 R
15 cm

gerieft
serrated
striée
estriado
ziggrinate



92
Luxator
3,5 mm
15 cm

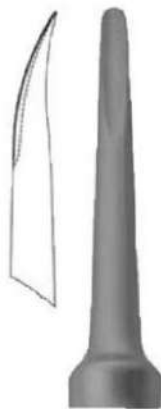

93
Luxator
3,5 mm
15 cm



93 Z
Luxator
3,5 mm
15 cm

gezahnt
saw edge
dentelés
dentadas
dentate



95
Luxator
4,5 mm
15 cm

Luxator

Instrumente zum Durchtrennen der zahnfixierenden Ligamente. Die sehr flache und scharfkantige Form der Arbeitsenden erlaubt ein schonendes Eindringen in den Parodontalspalt. Hier wird der Luxator in ausschließlich rotierender und schneidender Bewegung eingesetzt und dadurch die Alveole schonend erweitert.

Das traditionelle horizontale Aushebeln birgt hohe Bruchgefahr. Ein vertikales Aushebeln ist mit den traditionellen Hebeln nur bedingt möglich. So ist mit der Konstruktion der Luxatoren eine nahezu ideale Synthese zwischen traditionellem Hebel und Periotom gelungen. Unterstützend wirkt vor allem die negative Krümmung.

Luxators

Dental instrument to sever tooth-fixed ligaments. The extremely flat and sharp edged form of the working ends allows a very gentle penetration into the periodontal gap. Here, the luxator is used only in a rotating and cutting manner and allows a very gentle widening of the alveole.

Luxateurs

Le Luxateur est un instrument destiné à l'extraction par une technique de séparation des tissus et de la dent qui a la même fonction qu'un élévateur. Cet instrument possède une lame extra-plate et tranchante de manière à sectionner les ligaments.

Par des mouvements de rotations et de coupe il mobilise la dent à l'inverse de l'élévateur qui élève, mobilise et sert de levier. L'avantage du Luxateur est, qu'il diminue les traumatismes exercés sur la dent et les tissus adjacents.



TUFFRO

The Mangalm Surgical Co.



792/11
Beck
18,5 cm

gezahnt
saw edge
denteles
dentadas
dentate



792/1
Heidbrink
19,5 cm



792/2
Heidbrink
19,5 cm



792/3
Heidbrink
19,5 cm



792/4
Heidbrink
19,5 cm

gezahnt
saw edge
denteles
dentadas
dentate



792/5
Heidbrink
19,5 cm

gezahnt
saw edge
denteles
dentadas
dentate



792/6
Heidbrink
19,5 cm

gezahnt
saw edge
denteles
dentadas
dentate



47 PF
19 cm



48 PF
19 cm



792/10
Beck
18,5 cm

gezahnt
saw edge
denteles
dentadas
dentate

Dental



TUFFRO

The Mangalm Surgical Co.

Dental



793/AS 1
13,5 cm



793/AS 3
Heidbrink
13,5 cm



793/AS 2
Heidbrink
13,5 cm



793/AS 1N
Heidbrink
13 cm



793/AS 3N
Heidbrink
13,5 cm



793/AS 2N
Heidbrink
13,5 cm



794/332
Howard-Apexo
2
14,5 cm



794/334
Howard-Apexo
3
14,5 cm



794/333
Howard-Apexo
1
15 cm



794/340
Heidbrink
2
14,5 cm



794/342
Heidbrink
3
14,5 cm



794/341
Heidbrink
1
14,5 cm



795/327
Warwick-James
2
15,5 cm



795/329
Warwick-James
3
15,5 cm



795/328
Warwick-James
1
16 cm



TUFFRO

The Mangalm Surgical Co.



1291/202
1 / 3652
19 cm



1291/203
2 / 3662
17,5 cm



794 / 5 A
Davis # 10
21 cm



794 / 5 B
Davis # 11
21 cm



794 / 7 S
Seldin
19,5 cm



794 / 200
Davis
20 cm

Dental



TUFFRO

The Mangalm Surgical Co.

Dental



792/7
Davis # 1
19,5 cm

gezahnt
saw edge
denteles
dentadas
dentata



794/323
Davis # 1
18,5 cm

Achtkantgriff / gerieft
Octagonal handle / serrated
Manche octagonal / striée
Mango octagonal / estriado
Manico ottagonale / zigrinato



794/322
Davis # 2
18,5 cm



794/324
Davis # 3
18,5 cm



794/337
West # 1
16,5 cm

Achtkantgriff / glatt
Octagonal handle / smooth
Manche octagonal / lisse
Mango octagonal / lisa
Manico ottagonale / lisse



794/336
West # 2
17 cm



794/338
West # 3
17 cm



TUFFRO

The Mangalm Surgical Co.

Dental



796/1
Chompret
16,5 cm

Hohlgriff
Hollow Handle
Poignée creuse
Mango hueco
Manico cavo



796/2
Chompret
16,5 cm

Hohlgriff
Hollow Handle
Poignée creuse
Mango hueco
Manico cavo



796/3
Chompret
16,5 cm

Hohlgriff
Hollow Handle
Poignée creuse
Mango hueco
Manico cavo



796/1M
16 cm

Griff massiv
Handle solid
Manche massive
Mango sólido
Manico solida



796/7S
15,5 cm

Griff massiv
Handle solid
Manche massive
Mango sólido
Manico solida



796/8
15,5 cm

Griff massiv
Handle solid
Manche massive
Mango sólido
Manico solida



1/2

796/7
17 cm

Griff massiv
Handle solid
Manche massive
Mango sólido
Manico solida



1/2

796/7 A
17 cm



1/2

796/17
17 cm

Griff massiv
Handle solid
Manche massive
Mango sólido
Manico solida

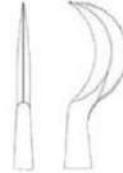

gezahnt
saw edge
dentalés
dentadas
dentate



1/2

796/17 A
17 cm



TUFFRO

The Mangalm Surgical Co.

Dental



798 / 1
Morrison
Ø 3,5 mm
11,5 cm

798 / 2
Morrison
Ø 3 mm
11,5 cm



798 / 5
Carroll-Girard
10 cm



TUFFRO

The Mangalm Surgical Co.

All in *1)
komplett mit Art No.
complete with Art No.
complet avec Art No.
completo con Art No.

2595 A, 2595 B, 2595 C, 2595 / 1 G, 2595 / 1 S, 2595 / 1 ST
2595 A, 2595 B, 2595 C, 2595 / 1 G, 2595 / 1 S, 2595 / 1 ST
2595 A, 2595 B, 2595 C, 2595 / 1 G, 2595 / 1 S, 2595 / 1 ST
2595 A, 2595 B, 2595 C, 2595 / 1 G, 2595 / 1 S, 2595 / 1 ST
2595 A, 2595 B, 2595 C, 2595 / 1 G, 2595 / 1 S, 2595 / 1 ST

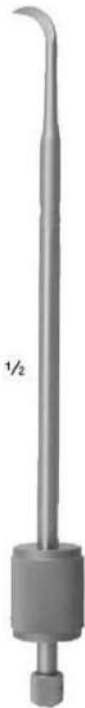

2595/1
All in *1)
21 cm



2595 A
Single
8 cm



2595 B
Single
8 cm



2595 C
Single
8 cm



2595/1 G
Single
2,7 cm



2595/1 S
Single
14,3 cm



2595/1 ST
Single
4 cm

All in *2)
komplett mit Art No.
complete with Art No.
complet avec Art No.
completo con Art No.

2595 A, 2595 B, 2595 C, 2595 / 2 G, 2595 / 2 S, 2595 / 1 ST
2595 A, 2595 B, 2595 C, 2595 / 2 G, 2595 / 2 S, 2595 / 1 ST
2595 A, 2595 B, 2595 C, 2595 / 2 G, 2595 / 2 S, 2595 / 1 ST
2595 A, 2595 B, 2595 C, 2595 / 2 G, 2595 / 2 S, 2595 / 1 ST
2595 A, 2595 B, 2595 C, 2595 / 2 G, 2595 / 2 S, 2595 / 1 ST



2595/2
All in *2)
21 cm



2595 A
Single
8 cm



2595 B
Single
8 cm



2595 C
Single
8 cm



2595/2 G
Single
2,7 cm



2595/2 S
Single
14 cm



2595/1 ST
Single
4 cm

Dental



TUFFRO

The Mangalm Surgical Co.

Dental



All in '3)
 komplett mit Art No. 2595 / 4 A, 2595 / 4 B, 2595 / 4 C, 2595 / 2 G, 2595 / 2 S, 2595 / 1 ST
 complete with Art No. 2595 / 4 A, 2595 / 4 B, 2595 / 4 C, 2595 / 2 G, 2595 / 2 S, 2595 / 1 ST
 complet avec Art No. 2595 / 4 A, 2595 / 4 B, 2595 / 4 C, 2595 / 2 G, 2595 / 2 S, 2595 / 1 ST
 completo con Art No. 2595 / 4 A, 2595 / 4 B, 2595 / 4 C, 2595 / 2 G, 2595 / 2 S, 2595 / 1 ST
 completo di Art No. 2595 / 4 A, 2595 / 4 B, 2595 / 4 C, 2595 / 2 G, 2595 / 2 S, 2595 / 1 ST



2595/6
All in '4)

All in '4)
 komplett mit Art No. 2595 / 7, 2595 / 1 G, 2595 / 1 S
 complete with Art No. 2595 / 7, 2595 / 1 G, 2595 / 1 S
 complet avec Art No. 2595 / 7, 2595 / 1 G, 2595 / 1 S
 completo con Art No. 2595 / 7, 2595 / 1 G, 2595 / 1 S
 completo di Art No. 2595 / 7, 2595 / 1 G, 2595 / 1 S





TUFFRO

The Mangalm Surgical Co.

Dental

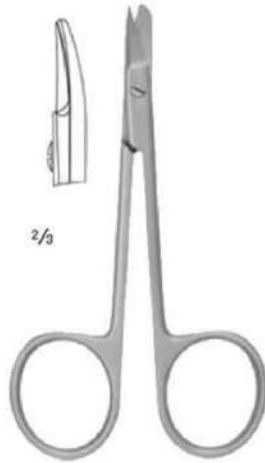

2/3

32 K

9,5 cm

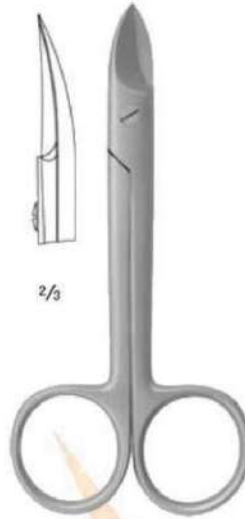

2/3

2610/2

Beebee
10,5 cm

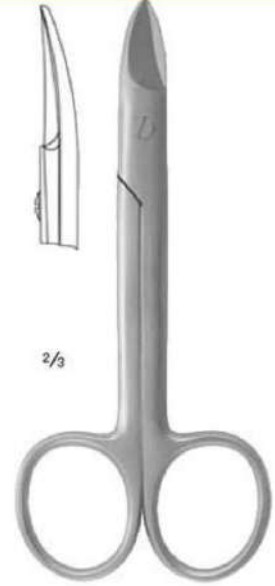

2/3

2620/2

Beebee
12 cm

gezahnt
saw edge
dentelés
dentadas
dentate

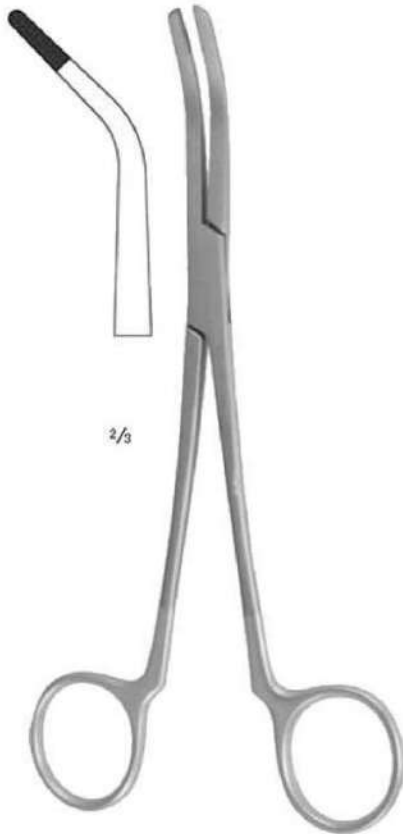

2/3

2594 TC

Wynmann
17 cm



2/3

2684

Baade
15 cm



2/3

2685

Baade
16 cm



TUFFRO

The Mangalm Surgical Co.

Dental

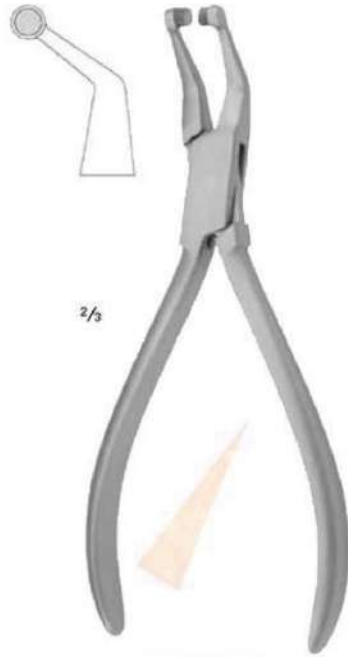

2706
14 cm



2700
How
13,5 cm



2707 TC
Weingart
14,5 cm

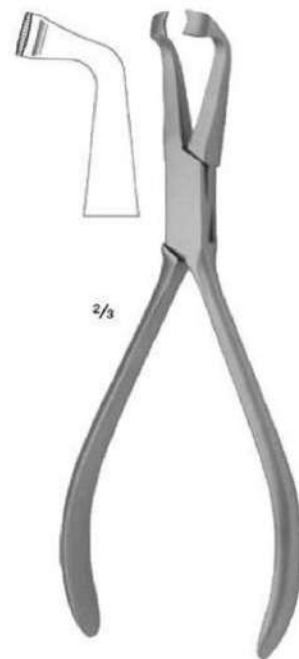

2708
Dr. Krause-Hohenstein
14,5 cm



TUFFRO

The Mangalm Surgical Co.

Dental

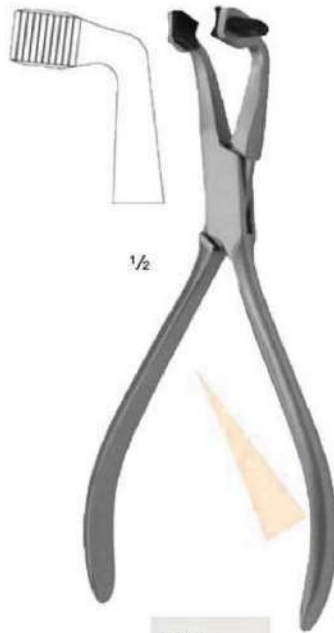

1/2

2693
Gum insert
for Art No 2709

Gummeinsatz für	Art No 2709 (1 pcs)
Gum insert for for	Art No 2709 (1 pcs)
Embout caoutchouc pour	Art No 2709 (1 pcs)
Punta caucho para	Art No 2709 (1 pcs)
Tassello di gomma per	Art No 2709 (1 pcs)

2709
14 cm

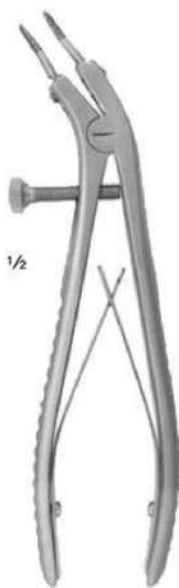

1/2

2746/1
13 cm



1/2

2746/2
12,5 cm



1/2

2746/3
12,5 cm



2746/4



2746/5



Teleskopkronenzange mit auswechselbaren
Diamant-Einsätzen

Telescopic crown pliers with exchangeable
diamond inserts

Pince télescopique à couronnes avec inserts en
diamant interchangeables

Alicates telescópicos para coronas con piezas
de inserción de diamante intercambiables

Pinzette telescopiche per corona con inserti in
diamante intercambiabili

Ersatzspitzen
Replacement tips
Pointes de rechange
Puntas de recambio
Coppia di punte di ricambio



TUFFRO

The Mangalm Surgical Co.



1/2

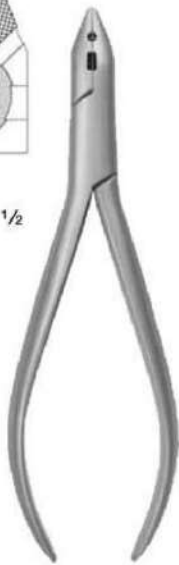

2815
Universal
16 cm

Universal Kramponzange
Universal pliers
Pinces universelles
Alicates universales
Tenaglie universali

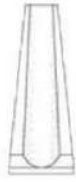

1/2



2885
Mc Kellops
16,0 cm

Bügelbiegezange
Bar bending pliers
Pinces à plier les barres
Alicates para doblar barras
Pinze per barre e fili



1/2

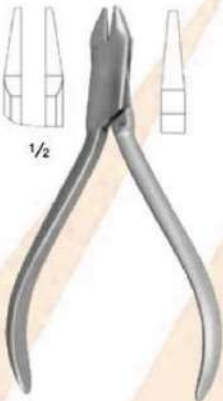

2865
Aderer
11,5 cm

Drathbiegezange
Wire bending pliers
Pinces à courber les fils
Alicates para doblar alambre
Pinze per piegare fili

2870
Aderer
13 cm



1/2

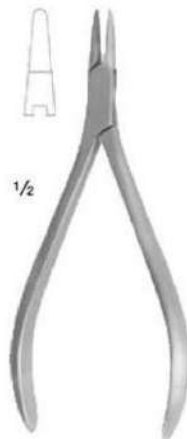

3006 TC
11,5 cm

Knochenplattenbiegezange
Bending plier for plates
Pince à courber plaques
Alicates para ortodoncia y protesis



1/2

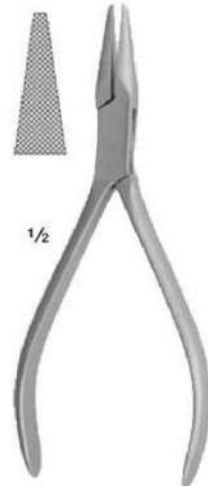

3060
14 cm

Flachzange
Flat nose plier
Pinces plates
Alicates de picos chatos
Pinze a punte platte

Dental



TUFFRO

The Mangalm Surgical Co.

Dental



1/2

für weiche Drähte bis
for soft wires up to
pour fils mous jusqu'à
para alambres blandos hasta
per fili molli fino a
Ø 2,3 mm

für harte Drähte bis
for hard wires up to
pour fils durs jusqu'à
para alambres duros hasta
per fili metallici duri fino a
Ø 1,5 mm

3080

14,0 cm

Seitenschneider
Wire cutter
Pince coupante
Alicates para cortar alambre
Pinze per troncare fili

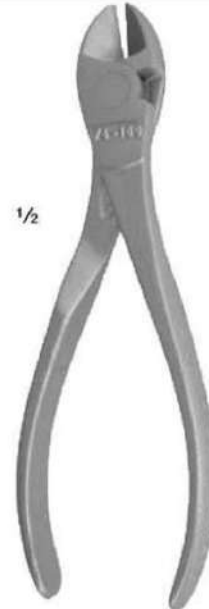

1/2

für weiche Drähte bis
for soft wires up to
pour fils mous jusqu'à
para alambres blandos hasta
per fili molli fino a
Ø 2,8 mm

für harte Drähte bis
for hard wires up to
pour fils durs jusqu'à
para alambres duros hasta
per fili metallici duri fino a
Ø 2,0 mm

3095

16,5 cm

Seitenschneider
Wire cutter
Pince coupante
Alicates para cortar alambre
Pinze per troncare fili

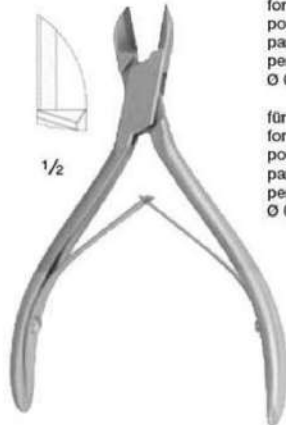

1/2

für weiche Drähte bis
for soft wires up to
pour fils mous jusqu'à
para alambres blandos hasta
per fili molli fino a
Ø 0,7 mm

für harte Drähte bis
for hard wires up to
pour fils durs jusqu'à
para alambres duros hasta
per fili metallici duri fino a
Ø 0,5 mm

3105 TC

11,5 cm

Seitenschneider
Wire cutter
Pince coupante
Alicates para cortar alambre
Pinze per troncare fili

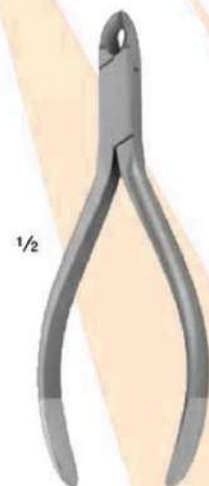

1/2

für weiche Drähte bis
for soft wires up to
pour fils mous jusqu'à
para alambres blandos hasta
per fili molli fino a
Ø 0,6 mm

für harte Drähte bis
for hard wires up to
pour fils durs jusqu'à
para alambres duros hasta
per fili metallici duri fino a
Ø 0,4 mm

3110 TC

13,0 cm

Drahtschneidezangen
Wire cutter
Pince coupante
Alicates para cortar alambre
Pinze per troncare fili



TUFFRO

The Mangalm Surgical Co.



1/2

für weiche Drähte bis
for soft wires up to
pour fils mous jusqu'à
para alambres blandos hasta
per fili molli fino a
Ø 1,3 mm

für harte Drähte bis
for hard wires up to
pour fils durs jusqu'à
para alambres duros hasta
per fili metallici duri fino a
Ø 1,0 mm

3120 TC

14,5 cm

Kopfschneider
Wire cutter, front action
Pince coupantes frontales
Alicates frontal para cortar alambre
Tenaglie tagliafili frontali

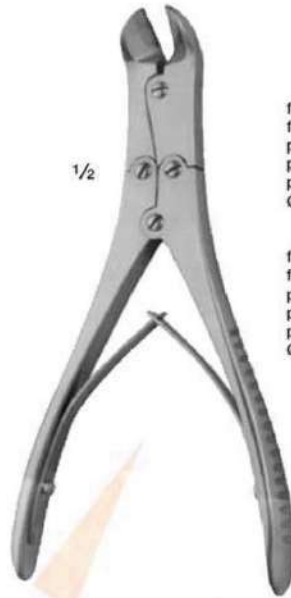

1/2

für weiche Drähte bis
for soft wires up to
pour fils mous jusqu'à
para alambres blandos hasta
per fili molli fino a
Ø 2,0 mm

für harte Drähte bis
for hard wires up to
pour fils durs jusqu'à
para alambres duros hasta
per fili metallici duri fino a
Ø 1,6 mm

3130 TC

16 cm

Drahtschneidezange
Wire cutter
Pince coupante
Alicates para cortar alambre
Pinze per troncare fili



1/2

2200 / 1
Fahnenstock
12,5 cm



1/2

2200 / 2
Fahnenstock
18 cm



1/2

2210 / 1
Lessmann
13 cm



1/2

2210 / 2
Lessmann
17,5 cm

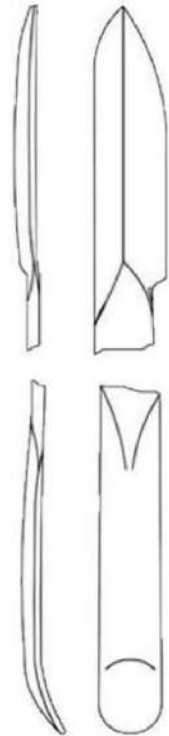

Dental



TUFFRO

The Mangalm Surgical Co.

Dental



1/3

1159-1
Manicure Set, black
20 cm x 15 cm

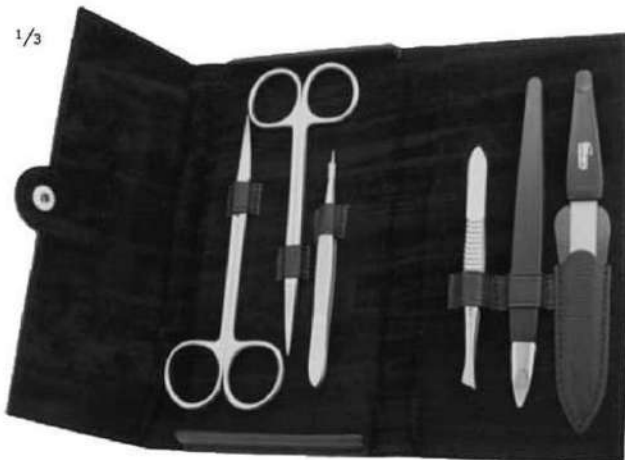

1/3

1159
Manicure Set, black
20 cm x 15 cm



2/3

1155-7
9 cm



2/3

1155-8
Lefthander
9 cm



TUFFRO

The Mangalm Surgical Co.

Dental



600/151 AS
151 AS
15 cm

Zähne, universal
Teeth, universal
Dentes, universal
Dientes, universal
Denti, universale



600/151 S
151 S
14,5 cm

Zähne und Wurzeln, universal
Teeth and roots, universal
Dentes et racines, universal
Dientes y raíces, universal
Denti e radici, universale



640/23 S
23 S
14,5 cm

Molaren
Molars
Molaires
Molares
Denti molari



645/17 SK
17 SK
12 cm

Molaren
Molars
Molaires
Molares
Denti molari



645/23 SK
23 SK
12 cm

Molaren
Molars
Molaires
Molares
Denti molari



645/151 SK
151 SK
12 cm

645/151 SKP
151 SKP
12 cm

Zähne und Wurzeln, universal
Teeth and roots, universal
Dentes et racines, universal
Dientes y raíces, universal
Denti e radici, universale





TUFFRO

The Mangalm Surgical Co.



111 P
special
17 cm

Schneide- und Eckzähne
Incisors and cuspids
Incisivos et caninos
Denti incisivi medi e denti canini



144
special
19 cm

144 P
special
19 cm

Wurzeln
Roots
Racines
Raices
Radici

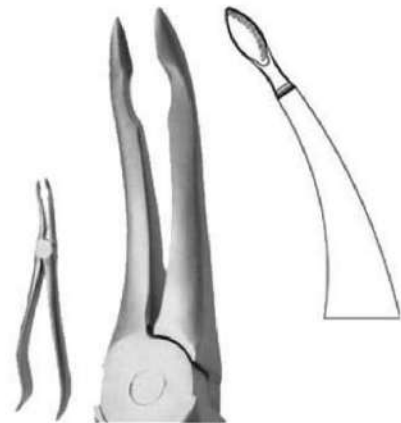

144 E
special
18,5 cm

144 EP
special
18,5 cm

144 EPS
special
18,5 cm

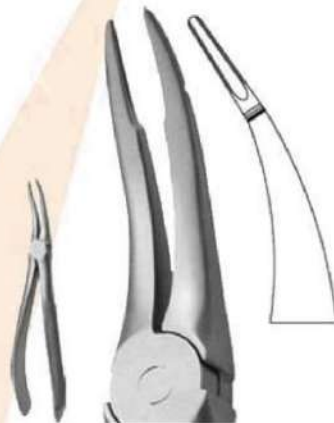

144 S
special
18,5 cm

144 SP
special
18,5 cm

Wurzeln
Roots
Racines
Raices
Radici



1219
special
16 cm

1219 P
special
16 cm

Dritte Molaren
Third molars
Troisièmes molaires
Terceros molares
Denti del giudizio

Dental



TUFFRO

The Mangalm Surgical Co.

Dental



22 1/2 R
special
17,5 cm



22 1/2 RP
special
17,5 cm



Molaren und dritte Molaren
Molars and third molars
Molaires et troisièmes molaires
Molares y terceros molares
Denti molari e denti del giudizio



22 1/2 L
special
17,5 cm



22 1/2 LP
special
17,5 cm



Molaren und dritte Molaren
Molars and third molars
Molaires et troisièmes molaires
Molares y terceros molares
Denti molari e denti del giudizio



79 AS
special
17 cm



Dritte Molaren
Third molars
Troisièmes molaires
Terceros molares
Denti del giudizio



145
special
17 cm



Wurzeln
Roots
Racines
Raíces
Radici



522 P
special
15 cm



Molaren
Molars
Molaires
Molares
Denti molari



586
special
15,5 cm



586 P
special
15,5 cm



Molaren
Molars
Molaires
Molares
Denti molari



TUFFRO

The Mangalm Surgical Co.



602 P
special
16,5 cm

Dritte Molaren
Third molars
Troisièmes molaires
Terceros molares
Denti del giudizio

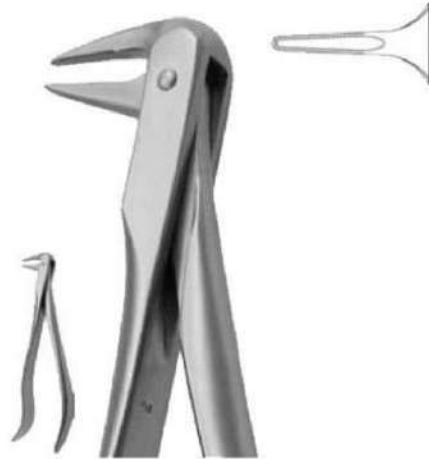

605 P
special
14,5 cm

Wurzeln
Roots
Racines
Raíces
Radici



605 D
special
14,5 cm

Wurzeln
Roots
Racines
Raíces
Radici



606 D
special
14,5 cm

Wurzeln
Roots
Racines
Raíces
Radici



Dental



TUFFRO

The Mangalm Surgical Co.

Dental



600/W 1
1 Winter
19 cm

Schneidezähne- und Eckzähne
Incisors and cuspids
Incisives et canines
Incisivos y caninos
Denti incisivi e denti canini



600/1 AS
1 AS
17,5 cm

Schneidezähne- und Eckzähne
Incisors and cuspids
Incisives et canines
Incisivos y caninos
Denti incisivi e denti canini

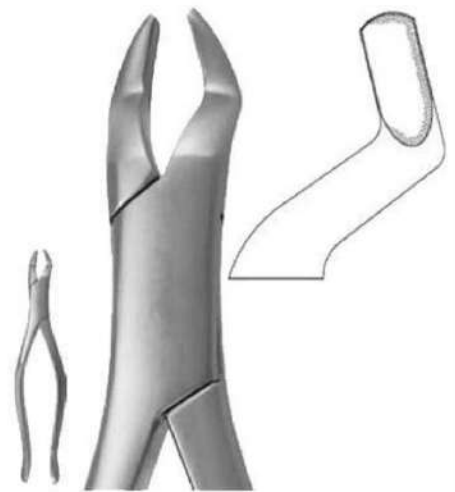

600/10 S
10 S
18 cm

Molaren und dritte Molaren
Molars and third molars
Molaires et troisièmes molaires
Molares y terceros molares
Denti molari e denti del giudizio



600/18 L
18 L
17 cm

Molaren, links
Molars, left
Molaires, gauche
Molares, izquierdo
Denti molari, sinistra



600/18 R
18 R
17 cm

Molaren, rechts
Molars, right
Molaires, droit
Molares, derecho
Denti molari, destra





TUFFRO

The Mangalm Surgical Co.

Dental



600/32
32 Parly
19 cm

Molaren, Prämolaren und Wurzeln
Molars, biscuspids and roots
Molaires, prémolaires et racines
Molares, premolares y raíces
Denti molari, denti premolari e radici

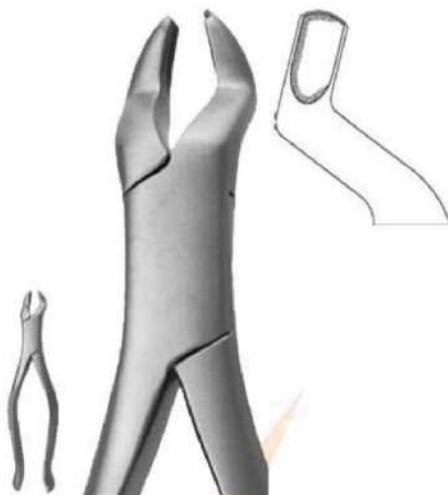

600/53 L
53 L
18 cm

Molaren, links
Molars, left
Molaires, gauche
Molares, izquierdo
Denti molari, sinistra



600/53 R
53 R
18 cm

Molaren, rechts
Molars, right
Molaires, droit
Molares, derecho
Denti molari, destra

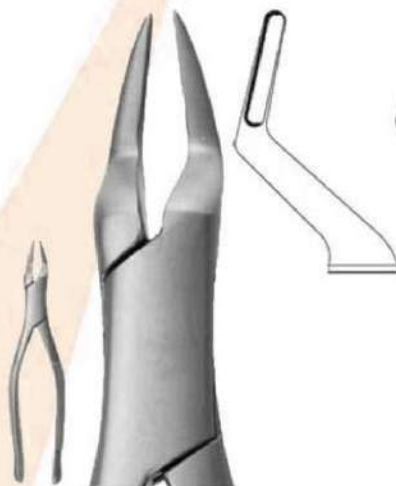

600/65
65
19 cm

Schneidezähne und Wurzeln
Incisors and roots
Incisives et racines
Incisivos y raíces
Denti incisivi e radici

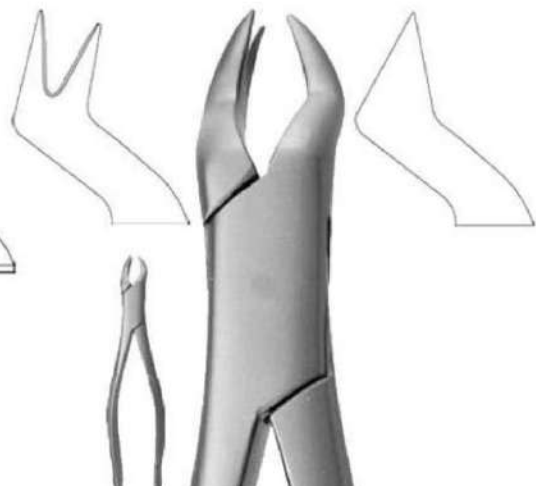

600/88 L
88 L Nevius
18,5 cm

Molaren, links
Molars, left
Molaires, gauche
Molares, izquierdo
Denti molari, sinistra



TUFFRO

The Mangalm Surgical Co.

Dental



600 / 88 R
88 R Nevius
18,5 cm

Molaren, rechts
Molars, right
Molaires, droit
Molares, derecho
Denti molari, destra



600 / 150
150 Cryer
18 cm

600 / 150 D
150 Cryer
18 cm



Prämolaren, Schneidzähne und Wurzeln
Bicuspidis, incisors and roots
Prémolaires, incisives et racines
Premolares, incisivos y raíces
Denti premolari, denti incisivi e radici



600 / 150 AB
150 AB
18 cm

Prämolaren, Schneidzähne und Wurzeln
Bicuspidis, incisors and roots
Prémolaires, incisives et racines
Premolares, incisivos y raíces
Denti premolari, denti incisivi e radici



600 / 210 S
210 S
17,5 cm

Dritte Molaren
Third molars
Troisième molaires
Terceros molares
Denti del giudizio



600 / 273
273
18 cm

600 / 273 D
273
18 cm



Prämolaren, Schneidzähne und Wurzeln
Bicuspidis, incisors and roots
Prémolaires, incisives et racines
Premolares, incisivos y raíces
Denti premolari, denti incisivi e radici



TUFFRO

The Mangalm Surgical Co.



635 / 89
89
17 cm

Molaren, rechts
Molars, right
Molaires, droit
Molares, derecho
Denti molari, destra



635 / 90
90
17 cm

Molaren, links
Molars, left
Molaires, gauche
Molares, izquierdo
Denti molari, sinistra

Dental

600 / 286
286
18 cm

600 / 286 D
286
18 cm



Schneidezähne und Wurzeln
Incisors and roots
Incisives et racines
Incisivos y raíces
Denti incisivi e radici



TUFFRO

The Mangalm Surgical Co.

Dental



600 / 17
17
17 cm

Molaren
Molars
Molaires
Molares
Denti molari

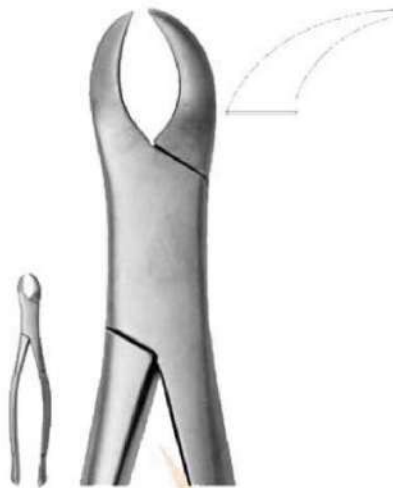

600 / 23
23
16,5 cm

Molaren
Molars
Molaires
Molares
Denti molari

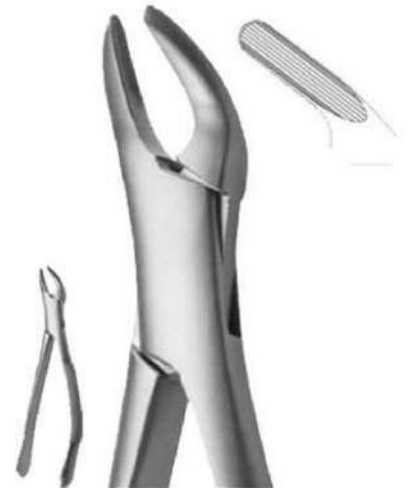

600 / 151
151 Cryer
17 cm

600 / 151 D
151 Cryer
17 cm

Prämolaren, Schneidezähne und Wurzeln
Biscuspids, incisors and roots
Prémolaires, incisives et racines
Premolares, incisivos y raíces
Denti premolari, denti incisivi e radici



600 / 151 AB
151 AB
17 cm

Prämolaren, Schneidezähne und Wurzeln
Biscuspids, incisors and roots
Prémolaires, incisives et racines
Premolares, incisivos y raíces
Denti premolari, denti incisivi e radici



600 / 217
217
16,5 cm

Dritte Molaren
Third molars
Troisièmes molaires
Terceros molares
Denti del giudizio



TUFFRO

The Mangalm Surgical Co.



600 / 222
222
18 cm

Molaren
Molars
Molaires
Molares
Denti molari

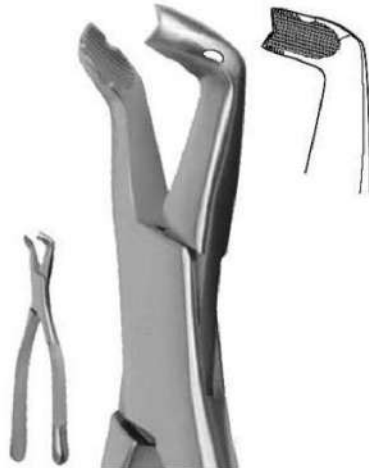

600 / 222 AS
222 AS
17,5 cm

Dritte Molaren
Third molars
Troisièmes molaires
Terceros molares
Denti del giudizio



600 / 274
274
16,5 cm

600 / 274 D
274
16,5 cm

Prämolaren, Schneidezähne und Wurzeln
Bicuspidis, incisors and roots
Prémolaires, incisives et racines
Premolares, incisivos y raíces
Denti premolari, denti incisivi e radici



600 / 274 N
274 N
17 cm

Prämolaren, Schneidezähne und Wurzeln
Bicuspidis, incisors and roots
Prémolaires, incisives et racines
Premolares, incisivos y raíces
Denti premolari, denti incisivi e radici

Dental



TUFFRO

The Mangalm Surgical Co.

Dental



680/1
Bein
2 mm
14 cm



21
Bein
2,5 mm
12,5 cm



680/2
Bein
3 mm
14 cm



680/3
Bein
4 mm
14 cm



1
Bein
3 mm
12,5 cm



17
Bein
4 mm
12,5 cm



725 / 3
Bein
3 mm
13,5 cm



725 / 4
Bein
4 mm
13,5 cm



TUFFRO

The Mangalm Surgical Co.



725/505
Kratzmann
Universal
13 cm



60 M
4 mm
12,5 cm



64
3 mm
12,5 cm



680/10
Kopp
14 cm



680/11
Kopp
14 cm



65
3 mm
14 cm



34
5 mm
12,5 cm



48
4 mm
14,5 cm



47
3 mm
15 cm



47 U
3 mm
15 cm

Dental



TUFFRO

The Mangalm Surgical Co.

Dental



24 P

2,5 mm
15 cm

fein gezahnt
fine serrated
denté fin
dentado fino
dentato fino



25 P

2,5 mm
15 cm

fein gezahnt
fine serrated
denté fin
dentado fino
dentato fino



26 P

2,5 mm
15 cm

fein gezahnt
fine serrated
denté fin
dentado fino
dentato fino



25

2,5 mm
15 cm



26

2,5 mm
15 cm



790 / 95

Omega
15 cm



32

2,5 mm
13,5 cm



790/1

1 Coupland

3 mm
14,5 cm



790/2

2 Coupland

3,5 mm
15 cm



790/3

3 Coupland

4 mm
15 cm



790/301

301

14 cm



TUFFRO

The Mangalm Surgical Co.



794 / 60
60
4 mm
14 cm



794 / 61
60 R
4 mm
14 cm



794 / 62
60 L
4 mm
14 cm



726 / 8
Crane-Pick
14,5 cm



726/25
14,5 cm



726/26
14,5 cm



726/34 S
Wolf
14,5 cm



735/1
Hyllin
4,5 mm
15 cm



735/2
Hyllin
3 mm
15 cm

Dental



TUFFRO

The Mangalm Surgical Co.

Dental



700/1
14,5 cm



700/8
Heidbrink
15 cm



700/9
Heidbrink
14,5 cm



700/10
Heidbrink
14,5 cm



700/36
Heidbrink
14 cm



700/37
Heidbrink
14 cm



785 / 63
Potts # 1
15,5 cm



785 / 64
Potts # 2
15,5 cm



TUFFRO

The Mangalm Surgical Co.



775 / 1
Winter
1 L
12 cm



775 / 2
Winter
1 R
12 cm



775 / 3
Winter
11 L
11,5 cm



775/4
Winter
11 R
11,5 cm



775/5
Winter
12 L
12 cm



775/6
Winter
12 R
12 cm



775/7
Winter
13 R
12 cm



775/8
Winter
13 R
12 cm



775/9
Winter
14 L
12,5 cm



775/10
Winter
14 R
12,5 cm

Dental



TUFFRO

The Mangalm Surgical Co.

Dental



775 / 68
12,5 cm



775 / 69
12,5 cm



780/1
Barry # 320
11,5 cm



780/2
Barry # 321
11,5 cm



780/7
Barry # 370
12 cm



780/8
Barry # 371
12 cm



777/14 L
12,5 cm



777/14 R
12,5 cm



TUFFRO

The Mangalm Surgical Co.



52
3 mm
15 cm



53
3,5 mm
15 cm



54
4,5 mm
15 cm



60
4 mm
15 cm



60 B
4 mm
15 cm



60 U
4 mm
16 cm



60 R
4 mm
15 cm



60 L
4 mm
15 cm



60 BR
4 mm
16 cm



60 BL
4 mm
16 cm

Dental



TUFFRO

The Mangalm Surgical Co.

Dental



63
4 mm
15 cm



66 B
5 mm
15 cm



66
5 mm
15 cm



69
4 mm
15 cm



64 A
3 mm
15 cm



67 R
4 mm
15,5 cm



67 L
4 mm
15,5 cm



68 R
4 mm
15 cm



68 L
4 mm
15 cm



68 A
4 mm
14,5 cm



68 B
4 mm
14,5 cm



TUFFRO

The Mangalm Surgical Co.



85
Pivot Point
3 mm
15 cm



85 U
Pivot Point
3 mm
16,5 cm



85 B
Pivot Point
3 mm
16,5 cm

Pivot Point Elevator-Series

Durch den Parabelschliff an der Instrumentenspitze und dem rautenförmigen Plateau ist ein schonendes Eindringen in den Interdentalraum bzw. Periodontalspalt optimal gewährleistet. Bedingt durch die Formgebung sind durch 180° Drehung vier Luxationsbewegungen möglich, je 2 x mesial und 2 x distal. Der Hebel arbeitet während des Luxationsvorgangs mit 5-7 Hypomochlien (Dreh- und Stützbewegungen). Dadurch ist er jedem herkömmlichen Hebel deutlich überlegen. Besonders wird die Luxation durch den Wellenschliff am Instrumentenrand begünstigt. Bedingt durch die Formgebung ist eine axial hebelnde Belastung der Instrumentenspitzen zu vermeiden, da dies zu Bruch führen kann.

The elliptically ground area on the instrument tip and the diamond-shaped plateau permit it to penetrate the interdental space and periodontal cleft optimally. Designed for 180° rotation for 4 luxation movements: 2 x mesial and 2 x distal. During luxation, the elevator exerts 5-7 hypomochlions (rotation and supporting actions), which is vastly superior to any conventional elevator. The grooves on the edge of the instrument provide for especially efficient luxation. The instrument tips are not designed for axial leverage as this may cause them to fracture.

Du fait de la taille elliptique de l'extrémité de l'instrument et du plateau losangique, une pénétration atraumatique dans l'espace inter-dentaire ou l'espace parodontal est assurée de manière optimale. La forme même permet aussi, par des rotations sur 180°, d'effectuer 4 mouvements de luxation, 2 du côté distal et 2 du côté mésial. Au cours de la manœuvre de luxation, l'élevateur travaille avec 5 à 7 sites d'hypomochlion (mouvements de rotation et d'appui). De ce fait, cet instrument est de loin supérieur à tout autre élévateur (max. 1 à 2 sites d'hypomochlion). La luxation est particulièrement facilitée par la présence de la taille ondulée dont sont pourvus les bords tranchants de l'instrument. Du fait de la forme de l'instrument, il faut éviter de soumettre l'extrémité de l'instrument à un effort de levier car cela peut provoquer sa fracture.

El rectificado elíptico sobre la punta del instrumento y la plataforma romboidal permiten la inserción óptima, no agresiva, en el espacio interproximal o el resquejío periodontal. El diseño del instrumento posibilita 4 movimientos de luxación al realizar un giro de 180°: 2 x mesial y 2 x distal. La palanca trabaja con 5-7 movimientos de giro y apoyo. Por este motivo es superior a cualquier palanca convencional. (máx 1-2 movimientos de giro y apoyo). La luxación es favorecida particularmente por la ondulación mecanizada sobre el margen del instrumento. Por la forma de los instrumentos deberá evitarse una carga de palanca axial sobre las puntas de los mismos, puesto que esto podría provocar su rotura.



85 A
Pivot Point
3 mm
15 cm



86
Pivot Point
3,5 mm
15 cm



86 R
Pivot Point
3,5 mm
15 cm



86 L
Pivot Point
3,5 mm
15 cm



87
Pivot Point
4 mm
15 cm

Dental



TUFFRO

The Mangalm Surgical Co.

Dental



720/1
Apical
#301
15 cm



720 / 2
Apical
302
15,5 cm



720 / 3
Apical
303
15,5 cm



720 / 4
Apical
304
15 cm



720 / 1 C
4,5 mm
15 cm



720 / 1 S
4,5 mm
15 cm



720 / 2 C
4 mm
15 cm



720 / 2 S
4 mm
15 cm



720 / 3 C
3,5 mm
15 cm



720 / 3 S
3,5 mm
15 cm



720 / 4 C
3 mm
15 cm



720 / 4 S
3 mm
14,5 cm



720 / 5 C
2,5 mm
15 cm



720 / 5 S
2,5 mm
15 cm



720 / 10 C
6 mm
15 cm



720 / 10 S
6 mm
15 cm