

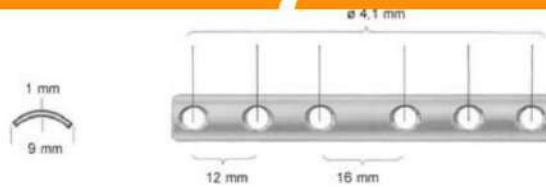

**TUFFRO**

The Mangalm Surgical Co.

**Orthopedic**



Länge mm Length mm	Lochanzahl No. of holes	Artikel Nr. Cat. No.
25	2	36.241.02
37	3	36.241.03
49	4	36.241.04
61	5	36.241.05
73	6	36.241.06
85	7	36.241.07
97	8	36.241.08

Passende Schrauben / Recommended Screws:	
Kortikal $\varnothing$ 3,5 mm	36.204.14 - 36.204.85
Spongiosa $\varnothing$ 3,5 mm Cancellous $\varnothing$ 3,5 mm	36.206.08 - 36.206.60
Spongiosa $\varnothing$ 4,0 mm Cancellous $\varnothing$ 4,0 mm	36.207.10 - 36.207.50

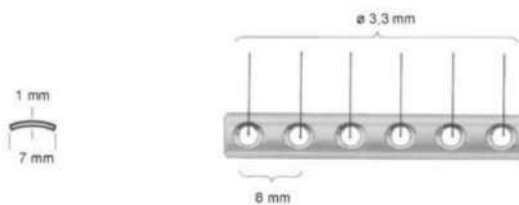

Länge mm Length mm	Lochanzahl No. of holes	Artikel Nr. Cat. No.
23	3	36.242.13
31	4	36.242.14
39	5	36.242.15
47	6	36.242.16
55	7	36.242.17
63	8	36.242.18
71	9	36.242.19

Passende Schrauben / Recommended Screws:	
Kortikal $\varnothing$ 2,7 mm	36.202.06 - 36.202.40



**TUFFRO**

The Mangalm Surgical Co. .

**Orthopedic**



Drahtwirbelzange  
Twisting Pliers

33.600.20 TC  
20,0 cm / 8"



Flachzange  
Flat Pliers

33.532.17  
17,0 cm / 6½"



Gripzange  
Vise Grip

33.533.18  
18,0 cm / 7"



Kopfschneider  
Wire Cutting Plier

33.540.16  
16,0 cm / 6¼"



**TUFFRO**

The Mangalm Surgical Co.



Knochendraht Ringe á 10 m  
Wire coils of 10 m

33.530.02 - 33.530.15  
weich, soft

33.531.03 - 33.531.10  
hart, hard

ø mm	weich soft	hart hard
0,2	33.530.02	
0,3	33.530.03	33.531.03
0,4	33.530.04	33.531.04
0,5	33.530.05	
0,6	33.530.06	33.531.06
0,7	33.530.07	
0,8	33.530.08	33.531.08
0,9	33.530.09	
1,0	33.530.10	33.531.10
1,2	33.530.12	
1,5	33.530.15	

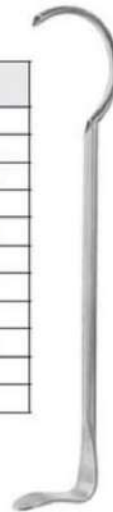

Drahtführungsinstrument  
Wire Passer

33.529.45  
45 mm



Drahtführungsinstrument  
Wire Passer

33.529.70  
70 mm



Kneitzange  
Wire Cutter

33.545.22 TC  
22,0 cm / 8½"  
Für Drähte bis ø 2,5 mm  
For wires up to ø 2.5 mm

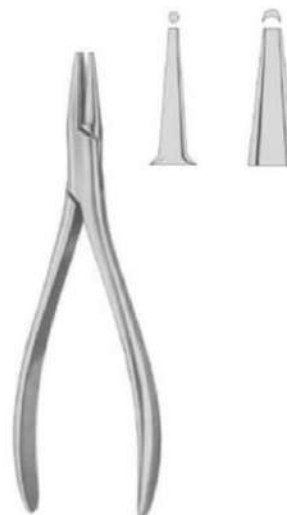

STADLER  
Drahtbiegezange  
Wire Bending Plier

33.726.16  
16,0 cm / 6¼"

Orthopedic



**TUFFRO**

The Mangalm Surgical Co. .

**Orthopedic**



Flachzange  
Extraction Plier

33.481.01 TC  
18,0 cm / 7"



PALMER  
Einschlaginstrument  
Impactor

33.481.02  
15,0 cm / 6"



PALMER  
Nachschlaginstrument  
Impactor

33.481.03  
17,5 cm / 7"



Steckschlüssel  
Wrench

33.602.13



LLOYD  
Vorschläger  
Impactor

33.602.18



LLOYD  
Vorschläger, Nagelzieher  
Impactor-Extractor

33.602.20



RITCHEY  
Vorbohrer  
Nail Starter

33.302.22



**TUFFRO**

The Mangalm Surgical Co.



SVEN JOHANSSON  
Vorschläger  
Impactor  
33.602.30



SVEN JOHANSSON  
Nachschläger  
Impactor  
33.602.34



Nagelzieher  
Nail Extractor  
33.602.50



Messhülse  
Measuring Gauge  
36.918.00

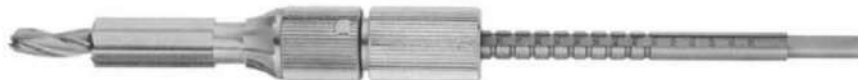

Dreifach Fräser  
Triple Reamer  
36.920.00



Gewindeschneider  
Tap  
36.922.00



Gewebehülse, kurz, zum Gewindeschneiden  
Guide Sleeve, short for tapping

36.924.01



Gewebehülse, lang, zum Verschrauben  
Guide Sleeve, long for screwing

36.924.02

Orthopedic



**TUFFRO**

The Mangalm Surgical Co.

**Orthopedic**



Führungsschaft  
Guide shaft

36.926.00



Kupplungsschraube  
Coupling Screw

36.926.02



Kupplungsschraube  
Coupling Screw

36.928.00



Neue Kupplungsschraube  
New Coupling Screw

36.928.01



Schlüssel  
Wrench

36.930.00



Neuer Schlüssel  
New Wrench

36.930.01



**TUFFRO**

The Mangalm Surgical Co.



Einschläger  
Impactor

36.932.00



Neuer Einschläger  
New Impactor

36.932.01



Griff  
Handle

36.934.00

Orthopedic



**TUFFRO**

The Mangalm Surgical Co.

**Orthopedic**



Biegehebel  
Bending Iron  
33.558.00



Ein- und Ausschlaginstrument  
Driver and Extractor  
33.562.24  
für Marknägel ø 2,4 mm  
for Intramedullary Pins ø 2,4 mm



33.562.32  
für Marknägel ø 3,2 mm  
for Intramedullary Pins ø 3,2 mm

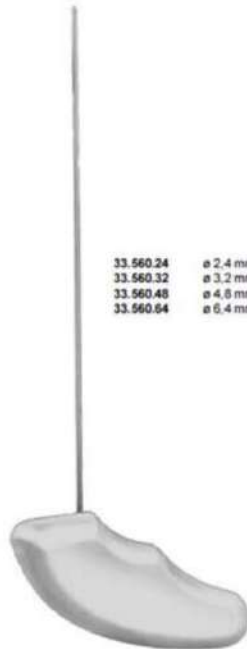

33.560.24 ø 2,4 mm  
33.560.32 ø 3,2 mm  
33.560.48 ø 4,8 mm  
33.560.64 ø 6,4 mm

Vorböhrer  
Rush Awl and Reamer  
33.560.24 - 33.560.64



33.809.01 klein / small  
33.809.02 mittel / medium  
33.809.03 groß / large

Drahtführungsinstrument  
Wire Guide  
33.809.01 - 33.809.03



33.562.48  
für Marknägel  
ø 4,8 mm  
for Intramedullary  
Pins ø 4,8 mm



33.562.64  
für Marknägel  
ø 6,4 mm  
for Intramedullary  
Pins ø 6,4 mm





**TUFFRO**

The Mangalm Surgical Co.



KÜNTSCHER  
Vorbohrer / Diamond Point Awl  
33.571.26



KÜNTSCHER  
Aufreiber / Reamer  
33.573.35



Führungsspieß / GuidePin  
33.581.35 - 33.585.60

cm	inch	ø 2,5 mm	ø 3,0 mm	ø 3,5 mm	ø 4,0 mm	ø 5,0 mm
35	13 3/4	33.581.35	33.582.35	33.583.35	33.584.35	33.585.35
46	18	33.581.46	33.582.46	33.583.46	33.584.46	33.585.46
60	23 1/2			33.583.60	33.584.60	33.585.60



KÜNTSCHER, Extraktor / Nail Extractor  
33.590.00



33.590.11



33.590.01



33.590.02



33.590.03



33.590.04



33.590.10

Orthopedic



**TUFFRO**

The Mangalm Surgical Co.

**Orthopedic**

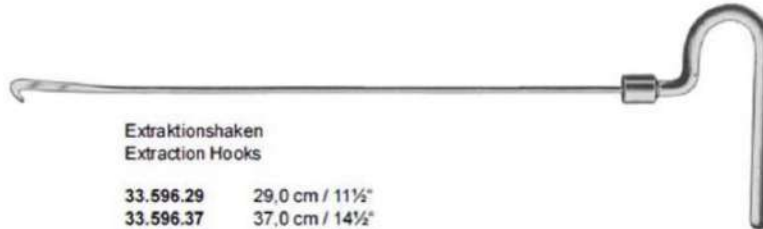

Extraktionshaken  
Extraction Hooks

33.596.29	29,0 cm / 11½"
33.596.37	37,0 cm / 14½"
33.596.42	42,0 cm / 16½"
33.596.49	49,0 cm / 19½"



Hautschutzplatte  
Skin Protector

36.049.02



KÜNTSCHER  
Vorschläger  
Nail Driver

33.586.21



KÜNTSCHER  
Vorschläger geschlitzt  
Slotted Nail Driver

33.587.21



KÜNTSCHER  
Einschlaginstrument  
Final Impactor

33.588.21



Schlitzhammer  
Slotted Hammer

33.598.30



**TUFFRO**

The Mangalm Surgical Co.



Bohrbüchse  
Drill Guide

33.125.27

für Bohrer ø 2,0 mm - for Drill Bit ø 2,0 mm  
für Kortkasschrauben ø 2,7 mm - for Cortical screws ø 2,7 mm



Schränkeisen  
Bending Iron

33.642.00  
13,0 cm / 5"



Biegezange für kleine Platten  
Bending Plier for small plates

33.650.14  
13,5 cm / 5½"



Raspatorium  
Periosteal Elevator

32.783.03  
18,0 cm · 3 mm



HOHMANN  
Knochenhebel  
Retractor

32.811.06  
6 mm



HOHMANN  
Knochenhebel  
Retractor

32.811.08  
8 mm



Knochenhebel  
Retractor

32.539.16  
16 mm

**Orthopedic**



**TUFFRO**

The Mangalm Surgical Co.

**Orthopedic**

Haltezangen für kleine Platten  
Holding Forceps for small plates



**32.398.99**  
12,0 cm / 4 $\frac{1}{4}$ "



**32.306.12**  
12,0 cm / 4 $\frac{1}{4}$ "

Repositionszangen  
Reduction Forceps



**32.308.14**  
13,5 cm / 5 $\frac{1}{4}$ "



**32.409.13**  
13,5 cm / 5 $\frac{1}{4}$ "



Spiralbohrer ø 3,5 mm  
Drill Bits ø 3.5 mm

33.356.35



Spiralbohrer ø 2.5 mm  
Drill Bits ø 2.5 mm

33.356.25

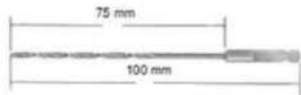

Spiralbohrer ø 2.0 mm  
Drill Bits ø 2.0 mm

33.356.20



Handstück  
Tap Handle

33.864.00  
11,0 cm / 4 1/2"



Kopfraumfräser  
Countersink

33.822.20  
7,0 cm / 2 3/4" ø 2,0 mm

für kleine Schrauben ø 2,7 mm / ø 3,0 mm / ø 4,0 mm  
for small screws ø 2,7 mm / ø 3,0 mm / ø 4,0 mm



Gewindeschneider  
Tap

33.830.35  
11,0 cm / 4 1/2" ø 3,5 mm

Steigung 1,25 mm - thread pitch 1,25 mm  
für Kortikalschrauben - for Cortical screws



Gewindeschneider  
Tap

33.840.35  
11,0 cm / 4 1/2" ø 3,5 mm

Steigung 1,75 mm - thread pitch 1,75 mm  
für Spongelschrauben - for Cancellous screws



Ziel- und Plattenbohrhülse  
Drill Guide and Sleeve

33.872.20

für Bohrer ø 2,0 mm  
for Drill Bits ø 2,0 mm



Steckbohrbüchse  
Insert Drill Sleeve

33.312.44

für Bohrer ø 2,5 mm / ø 2,7 mm  
for Drill Bits ø 2,5 mm / ø 2,7 mm

für Schrauben ø 2,7 mm / 3,5 mm  
for screws ø 2,7 mm / 3,5 mm



Gewebeschutzhülse und Bohrbüchse  
Tap Sleeve and Drill Sleeve

33.887.35

für Bohrer ø 2,5 mm  
for Drill Bits ø 2,5 mm

für Kortikalschrauben ø 3,5 mm  
for Cortical Screws ø 3,5 mm

für Gewindeschneider ø 3,5 mm  
for Tap ø 3,5 mm



Schraubenzieher  
Hexagonal Screwdriver

33.630.25  
19,5 cm / 7 1/4"

2,5 mm



Schraubenzieher-Einsatz  
Hexagonal Screwdriver Shaft

33.629.25  
10,0 cm / 4"

2,5 mm



**TUFFRO**

The Mangalm Surgical Co.

**Orthopedic**



Schraubenmeßgerät  
Screw Depth Gauge  
33.828.00  
16,0 cm / 6 1/4"



Scharfer Haken  
Sharp Hook  
33.842.39  
16,0 cm / 6 1/4"



Halteklammer  
Plate Holding Clip  
33.842.35



Schraubenpinzette  
Screw Forceps  
33.839.09  
8,0 cm / 3 1/4"



Bohrbüchse  
Drill Guide  
34.125.35

für Bohrer ø 2,5 mm - for Drill Bit ø 2,5 mm  
für Kortikalschrauben ø 3,5 mm - for Cortical screws ø 3,5 mm



Schränkeisen für kleine Platten  
Bending Iron for small plates

33.643.01  
14,5 cm / 5 1/2"



33.643.02  
14,5 cm / 5 1/2"



Biegeschablonen  
Bending Templates

33.676.06  
5-Loch / 5 holes



Biegeschablonen  
Bending Templates

33.676.08  
7-Loch / 7 holes



**TUFFRO**

The Mangalm Surgical Co.



Raspatorium klein  
Periosteal Elevator

**32.774.06**  
18,0 cm / 6 mm



HOHMANN  
Knochenhebel  
Retractor

**32.811.06**  
6 mm



HOHMANN  
Knochenhebel  
Retractor

**32.811.08**  
8 mm



HOHMANN  
Knochenhebel  
Retractor

**32.811.15**  
15 mm



Repositionszange  
Bone Reduction Forceps

**32.308.14**  
13,5 cm / 5¼"



Repositionszange  
Bone Reduction Forceps

**32.409.13**  
13,5 cm / 5¼"



Biegezange für kleine Platten  
Bending Plier for small plates

**32.650.14**  
13,5 cm / 5½"



Knochenhaltezange  
Bone Holding Forceps

**32.391.15**  
15,0 cm / 6"

**Orthopedic**



**TUFFRO**

The Mangalm Surgical Co.

**Orthopedic**



Schraubenzieher  
Screw driver

**33.628.35**  
25,0 cm / 10"

3,5 mm

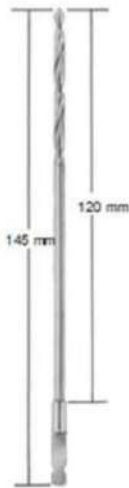

Bohrer  
Drill Bits

**33.356.32**  
ø 3,2 mm

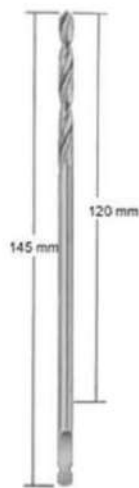

Bohrer  
Drill Bits

**33.356.45**  
ø 4,5 mm

ø 3,2 mm



für Malleolar  
for Malleolar screws

Kopfraumfräser  
Countersink

**33.824.32**  
12,0 cm / 4 3/4"

ø 4,5 mm



Kopfraumfräser  
Countersink

**33.826.45**  
18,0 cm / 7"



Griffstück für  
Gewindeschneider  
Tap Handle

**33.866.00**  
8,5 cm / 3 1/2"





**TUFFRO**

The Mangalm Surgical Co.

ø 4,5 mm



Gewindeschneider  
Tap

**33.830.45**  
13,0 cm / 5"

ø 4,5 mm



Gewindeschneider  
Tap

**33.832.45**  
13,0 cm / 5"

ø 6,5 mm



Gewindeschneider  
Tap

**33.840.65**  
20,0 cm / 5"



Gewebeschutzhülse  
Drill Sleeve

**33.885.35**  
11,0 cm / 4 1/2"

für Bohrer ø 3,2 mm  
for Drill Bits ø 3,2 mm  
für Schrauben ø 4,5 mm  
for screws ø 4,5 mm



Steck-Bohrbüchse  
Insert Drill Sleeve

**33.874.45**  
5,0 cm / 2"

ø 4,5 mm



Gewebeschutzhülse  
Drill Sleeve

**33.889.45**



Zielgerät  
Pointed Drill Guide

**33.881.45**  
15,0 cm / 6"

3,5 mm



Schraubendrehereinsatz  
Hexagonal Screwdriver

**33.629.35**  
11,5 cm / 4 1/2"



Schraubenmeßgerät  
Screw Depth Gauge

**33.829.01**  
22,0 cm / 8 3/4"



Scharfer Haken  
Sharp Hook

**33.842.39**  
16,0 cm / 6 1/4"

**Orthopedic**



**TUFFRO**

The Mangalm Surgical Co.

**Orthopedic**



40 mm  
für Bohrer ø 3,2 mm  
for Drill Bit ø 3,2 mm  
**Bohrbüchse**  
**Drill Sleeve**  
**34.105.40**  
11,5 cm / 4½"



für Bohrer ø 3,2 mm  
for Drill Bit ø 3,2 mm  
**Drill Sleeve for**  
**Tension Device**  
**Bohrlehre für**  
**Plattenspanner**  
**34.102.32**  
5,0 cm / 2"



**Plattenspanner**  
**Tension Device**  
**34.110.08**  
6,0 cm / 2½"



**Plattenspanner**  
**Tension Device Articulated**  
**34.111.16**  
9,0 cm / 3½"



**Kardanschlüssel**  
**Socket Wrench**  
**34.115.11**  
18,5 cm / 7½"



**Gabelschlüssel**  
**Wrench**  
**34.116.11**  
15,0 cm / 6"



40 mm  
für Bohrer ø 3,2 mm - for Drill Bit ø 3,2 mm  
für Kortikalschrauben ø 4,5 mm - for Cortical screws ø 4,5 mm  
**Bohrbüchse**  
**Drill Guide**  
**34.127.45**  
16,5 cm / 6½"



**Biegeschablone 5-Loch**  
**Bending Templates 5 Holes**  
**33.374.09**



**Biegeschablone 7-Loch**  
**Bending Templates 7 Holes**  
**33.674.12**



**Biegeschablone 9-Loch**  
**Bending Templates 9 Holes**  
**33.674.15**



**TUFFRO**

The Mangalm Surgical Co.



Schränkeisen für Standard Platten  
Bending Iron for Standard Plates

33.645.00



Klingenmeißel  
Seating Chisel

34.332.12  
32,0 cm / 12½"



Klingenmeißel  
Seating Chisel

34.332.13  
28,5 cm / 11½"



Ein- und Ausschlaginstrument  
Insertor / Extractor

34.332.15  
27,0 cm / 10½"



Schlitzhammer  
Slotted Hammer

34.332.20  
27,0 cm / 10½"



Nachschlaginstrument  
Impactor

34.332.21  
20,5 cm / 8½"

Orthopedic



**TUFFRO**

The Mangalm Surgical Co.

**Orthopedic**



Drahtwirbelzange  
Twisting Plier

33.500.20 TC  
20,0 cm / 8"



Flachzange  
Flat Pliers

33.532.17  
17,0 cm / 6½"



Grip Zange  
Vise Grip

33.533.18  
18,0 cm / 7"



Kopfschneider  
Wire Cutting Plier

33.540.16  
16,0 cm / 6¼"



Kneitzange für Drähte bis ø 2,5 mm  
Wire Cutter for wire up to ø 2.5 mm

33.545.22 TC  
22,0 cm / 8½"



**TUFFRO**

The Mangalm Surgical Co.



Drahteinführungsinstrument  
Wire Passer

33.529.45  
45 mm



Drahteinführungsinstrument  
Wire Passer

33.529.70  
70 mm



Draht, weich ø 1,0 mm  
Draht, weich ø 1,5 mm  
Wire soft ø 1.0 mm  
Wire soft ø 1.5 mm

33.530.10 - 33.530.15



STADLER  
Drahtbiegezange  
Wire Bending Forceps

87.626.16  
16,0 cm / 6 1/4"

Orthopedic



**TUFFRO**

The Mangalm Surgical Co.

**Orthopedic**



Spiralbohrer  
Drill Bits



Spiralbohrer  
Drill Bits



Flachbohrer  
Flat Drill



Kugelfräser  
Sphenal Bur



Konischer Fräser  
Conical Bur



Spiralbohrer  
Drill Bit

ø mm					
1,0		33.352.10			33.354.10
1,2		33.352.12			
1,5		33.352.15			33.354.15
1,8		33.352.18	33.358.18		
2,0	33.350.20	33.352.20	33.358.20		33.354.20
2,2		33.352.22	33.358.22		
2,5	33.350.25	33.352.25	33.358.25		33.354.25
2,8		33.352.28			33.354.28
3,0	33.350.30	33.352.30	33.358.30	33.359.30	33.359.31
3,2	33.350.32	33.352.32			33.354.32
3,5	33.350.35	33.352.35	33.358.35		33.354.35
4,0	33.350.40	33.352.40	33.358.40	33.359.40	33.354.40
5,0	33.350.50	33.352.50	33.358.50		33.359.50
6,0	33.350.60				33.354.60
7,0	33.350.70				



**TUFFRO**

The Mangalm Surgical Co.



ø mm	DOYEN	DOYEN	DOYEN	DOYEN	DOYEN
4,0	33.362.04	33.364.04			
6,0	33.362.06	33.364.06			
7,0					
8,0	33.362.08	33.364.08		33.368.08	
10,0	33.362.10	33.364.10		33.368.10	
12,0	33.362.12	33.364.12	33.366.12		33.370.12
13,0					
14,0	33.362.14	33.364.14			
15,0					33.370.15
16,0	33.362.16	33.364.16			
25,0					



ø mm	ALBEE	ALBEE	BOCHARDT	TOTI
4,0				
6,0				
7,0		33.374.07		
8,0	33.372.08			33.378.08
10,0	33.372.10			
12,0	33.372.12			
13,0			33.376.13	
14,0				
15,0				
16,0				
25,0				33.377.25

**Orthopedic**



**TUFFRO**

The Mangalm Surgical Co.

**Orthopedic**



Raspatorium  
Periosteal Elevator

32.779.06  
18,0 cm / 7"



Raspatorium  
Periosteal Elevator

32.783.03  
18,0 cm / 7"



33.628.25  
25,0 cm / 10"



33.628.35  
25,0 cm / 10"



33.672.17  
17,0 cm / 6 1/2"



LANE  
33.620.25  
25,0 cm / 10"







**TUFFRO**

The Mangalm Surgical Co.



**33.632.25**  
25,0 cm / 10"



**PHILIPS**  
**33.672.25**  
25,0 cm / 10"



**WILLIAMS**  
**33.624.24**  
24,0 cm / 9 1/2"

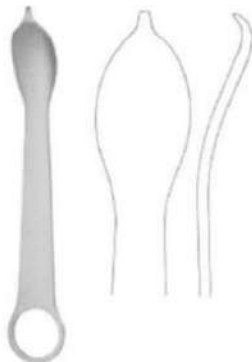

**32.539.16**  
16 mm

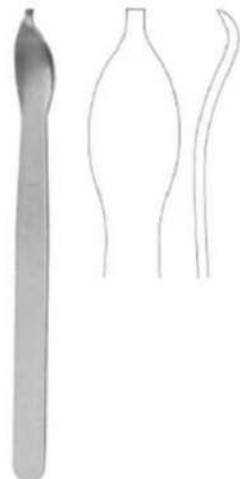

**32.539.15**  
15 mm

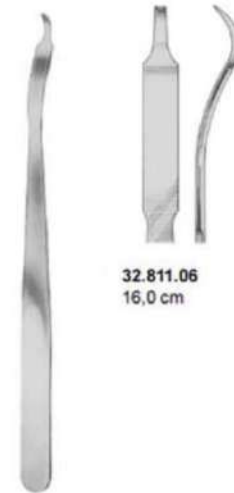

**32.811.06**  
16,0 cm



**32.811.08**  
16,0 cm

**MINI-HOHMANN**  
**32.811.06 - 32.811.08**

**Orthopedic**



**TUFFRO**

The Mangalm Surgical Co.

**Orthopedic**



Behälter mit Instrumentarium  
Case with Instruments

33.482.00

Behälter ohne Instrumentarium  
Case without Instruments

33.482.01

Einsätze  
Screw Driver Shafts



Schraubenziehergriff  
Screwdriver Handle

33.482.02  
14,5 cm / 5 1/2"



33.482.03  
14,0 cm / 5 1/2"



33.482.06  
14,0 cm / 5 1/2"



33.482.09  
14,0 cm / 5 1/2"



33.482.10  
14,0 cm / 5 1/2"



JACOBS  
Universalbohrfutter  
Universal Chuck

33.482.13  
7,5 mm / 3"



33.482.18  
14,0 cm / 5 1/2"

3,5 mm



33.482.19  
14,0 cm / 5 1/2"

2,5 mm



**TUFFRO**

The Mangalm Surgical Co.

Artikel-Nr.  
Cat. No.

**36.926.12** Plattenschneidezange  
12 cm, mit Hartmetall  
Plate cutting pliers  
12 cm, with Tungsten Carbide inserts

Artikel-Nr.  
Cat. No.

**36.926.13** Flachzange, 13,5 cm  
Flat pliers, 13,5 cm

Artikel-Nr.  
Cat. No.

**36.820.15** Plattenbiegezange ADERER, 15 cm  
Plate bending pliers ADERER, 15 cm

Artikel-Nr.  
Cat. No.

**36.972.15** Platten/Schrauben-Haltepinzette,  
TITAN, 15 cm  
Plates and screws holding forceps  
TITANIUM, 15 cm



**Orthopedic**



**TUFFRO**

The Mangalm Surgical Co.

**Orthopedic**

Artikel-Nr.  
Cat. No.

**33.545.18**

Plattenschneidezange  
18 cm, mit Hartmetall  
Plate cutting pliers,  
18 cm, with Tungsten Carbide inserts



Artikel-Nr.  
Cat. No.

**36.820.15**

Plattenbiegezange ADERER, 15 cm  
Plate bending pliers ADERER, 15 cm



Artikel-Nr.  
Cat. No.

**36.821.15**

Plattenbiegezange  
15 cm, mit Stift  
Plate bending pliers  
15 cm, with pin



**TUFFRO**

The Mangalm Surgical Co.

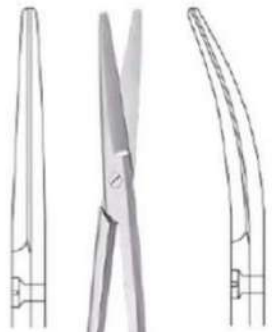

TC-Schneiden  
TC Cutting Edges



MAYO

14,5 cm/5 3/4"	08.164.14	08.165.14
17 cm/6 3/4"	08.164.17	08.165.17
23 cm/9"	08.164.23	08.165.23

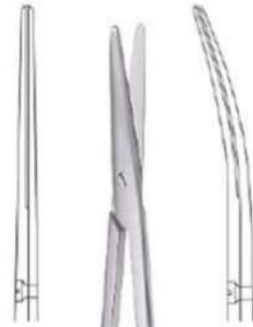

TC-Schneiden  
TC Cutting Edges



MAYO-STILLE

15 cm/6"	08.174.15	08.175.15
17 cm/6 3/4"	08.174.17	08.175.17

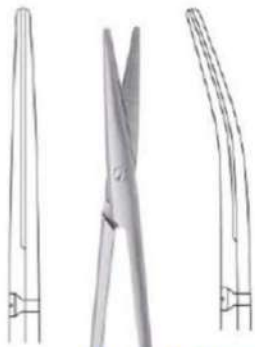

TC-Schneiden  
TC Cutting Edges



LEXER

16 cm/6 1/4"	08.194.16	08.195.16
--------------	-----------	-----------

Orthopedic



**TUFFRO**

The Mangalm Surgical Co.

**Orthopedic**



TC-Schneiden  
TC Cutting Edges

**METZENBAUM**

15 cm/6"	08.284.15	08.285.15
18 cm/7"	08.284.18	08.285.18
20 cm/8"	08.284.20	08.285.20
23 cm/9"	08.284.23	08.285.23



TC-Schneiden  
TC Cutting Edges

**METZENBAUM FINO**

15 cm/6"	08.286.15	08.287.15
18 cm/7"	08.286.18	08.287.18
20 cm/8"	08.286.20	08.287.20
23 cm/9"	08.286.23	08.287.23



08.297.14  
14,5 cm/5 3/4"

08.297.18  
18 cm/7"

TC-Schneiden  
TC Cutting Edges

**METZENBAUM FINO**



TC-Schneiden  
TC Cutting Edges

**KILNER**

12 cm/4 3/4"	08.314.12
15 cm/6"	08.314.15



**TUFFRO**

The Mangalm Surgical Co.



eine Schneide gezahnt  
one toothed cutting edge

TC-Schneiden  
TC Cutting Edges

**LOCKLIN**  
08.316.16  
16 cm/6¼"



TC-Schneiden  
TC Cutting Edges

**IRIS**  
08.344.11  
11,5 cm/4½"



**IRIS**  
08.345.11  
11,5 cm/4½"



Eine Schneide gezahnt  
One toothed cutting edge

TC-Schneiden  
TC Cutting Edges

**GOLDMAN FOX**  
08.823.13  
13 cm/5"



Mit TC-Einsätzen  
TC Lined

**ADSON**  
12 cm/4¾" 10.184.12  
15 cm/6" 10.184.15



Mit TC-Einsätzen  
TC Lined

**ADSON micro**  
12 cm/4¾" 10.173.12  
15 cm/6" 10.173.15



Mit TC-Einsätzen  
TC Lined

**GILLIES**  
10.272.16  
15,5 cm/6"

**Orthopedic**



TUFFRO

The Mangalm Surgical Co.

Orthopedic

ATRAUMA



DE BAKEY



DE BAKEY

Mit TC-Einsätzen  
TC Lined

1,5 mm	2,0 mm	2,7 mm	3,5 mm
6 x 12	6 x 12	6 x 12	6 x 12

15 cm/6"	11.404.15	11.412.15	11.414.15	11.416.15
19,5 cm/7¾"	11.404.19	11.412.19	11.414.19	11.416.19
24 cm/9½"	11.404.24	11.412.24	11.414.24	11.416.24

1,5 mm	2,0 mm	2,7 mm	3,5 mm
2 x 4	2 x 4	2 x 4	2 x 4

15 cm/6"	11.402.15	11.422.15	11.424.15	11.426.15
19,5 cm/7¾"	11.402.20	11.422.19	11.424.19	11.426.19
24 cm/9½"	11.402.24	11.422.24	11.424.24	11.426.24





TUFFRO

The Mangalm Surgical Co.

Mit TC-Einsätzen  
TC Lined

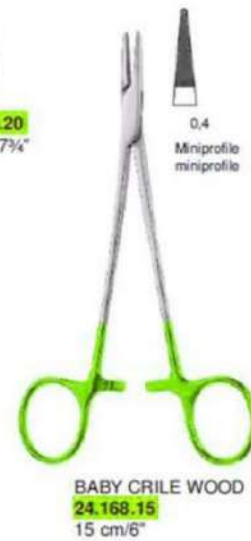
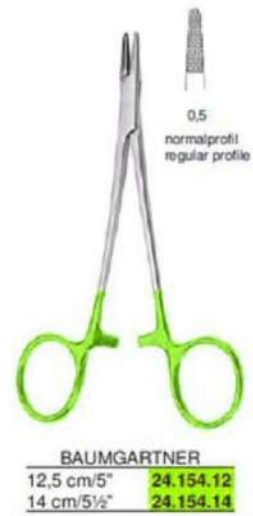
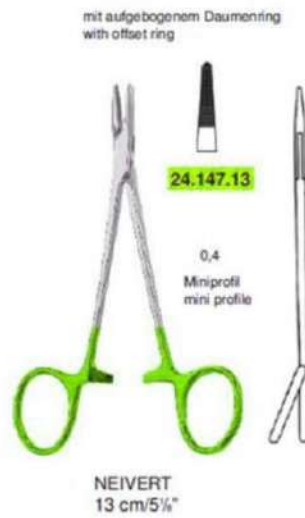

Orthopedic



TUFFRO

The Mangalm Surgical Co.

Orthopedic

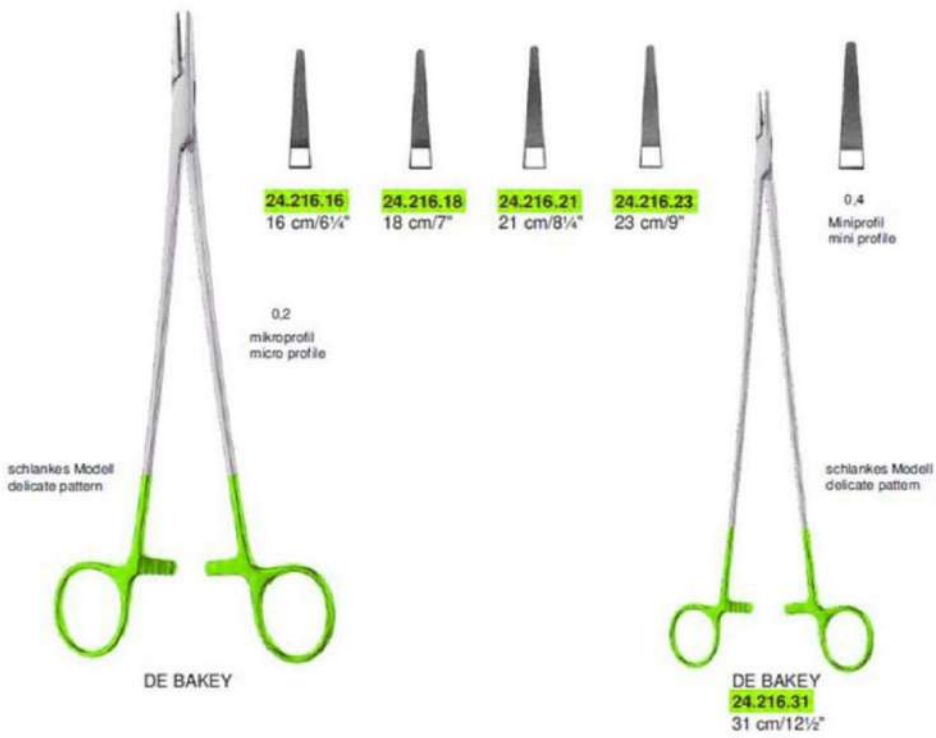



**TUFFRO**

The Mangalm Surgical Co.



CASTROVIEJO-  
JACOBSON

glattes Maul  
smooth jaw



glattes Maul  
smooth jaw



0,3  
Mikroprofil  
micro profile



0,3  
Mikroprofil  
micro profile



14,5 cm/5¾"	24.674.14	24.675.14	24.678.14	24.679.14
18 cm/7"	24.674.18	24.675.18	24.678.18	24.679.18
21 cm/8¼"	24.674.21	24.675.21	24.678.21	24.679.21
23 cm/9"	24.674.23	24.675.23	24.678.23	24.679.23

mit sperre  
with catch

glattes Maul  
smooth jaw



glattes Maul  
smooth jaw



0,3  
Mikroprofil  
micro profile



0,3  
Mikroprofil  
micro profile



14,5 cm/5¾"	24.694.14	24.695.14	24.698.14	24.699.14
18 cm/7"	24.694.18	24.695.18	24.698.18	24.699.18
21 cm/8¼"	24.694.21	24.695.21	24.698.21	24.699.21
23 cm/9"	24.694.23	24.695.23	24.698.23	24.699.23

ohne sperre  
without catch

**Orthopedic**



**TUFFRO**

The Mangalm Surgical Co.

**Orthopedic**



**BRUENINGS**  
48.107.19  
19 cm/7½"  
19 / 15 mm



**DOYEN**

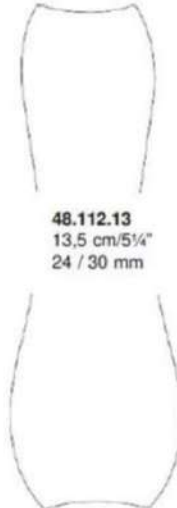

**48.112.13**  
13,5 cm/5¼"  
24 / 30 mm



**48.112.16**  
16 cm/6¼"  
30 / 34 mm

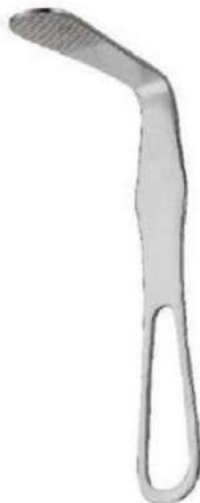

**HARTMANN**  
48.111.15  
15 cm/6"



72 x 23 mm



**TOBOLD**  
48.119.14  
14,5 cm/5¾"



85 x 24 mm



**TOBOLD**  
48.119.15  
15 cm/6"



88 x 25 mm



**TUFFRO**

The Mangalm Surgical Co.



WIEDER

48.115.01  
14 cm/5½"  
36 mm

48.115.02  
15 cm/6"  
43 mm

Lippen- und Wangenhalter  
Wire lip retractor



STERNBERG  
48.229.14  
14 cm/5½"



SIMPLEX  
48.230.11  
11 cm/4¼"

Zungenzangen  
Tongue Holding Forceps



CAWOOD-MINNESOTA  
48.233.15  
15 cm/6"  
20 mm



COLLIN  
48.250.16  
16 cm/6½"



YOUNG  
48.255.16  
16 cm/6½"

48.255.99  
Gummipolster (Paar)  
Rubber inserts (Pair)

Orthopedic



**TUFFRO**

The Mangalm Surgical Co.

**Orthopedic**



DENHARDT  
48.267.12  
12 cm/5"



ROSER-KOENIG  
16 cm/6¼" 48.270.16  
19 cm/7½" 48.270.19



HEISTER  
48.272.13  
13 cm/5¼"



MIDDELORPF

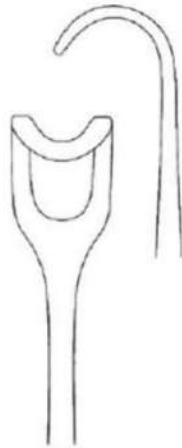

18.344.14  
21,5 cm/8½"  
14 x 17 mm

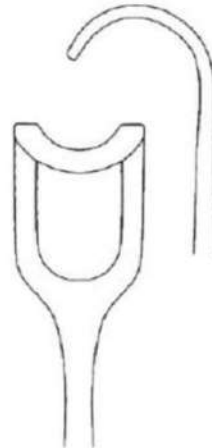

18.344.20  
22 cm/8¾"  
20 x 22 mm

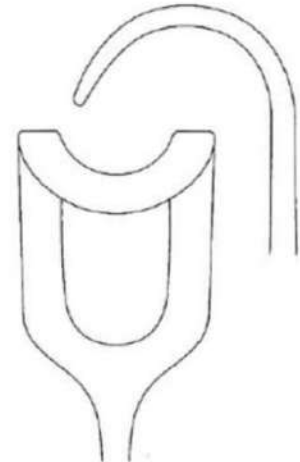

18.344.26  
23,5 cm/9¼"  
26 x 30 mm



**TUFFRO**

The Mangalm Surgical Co.



**BÜCHS**  
18.346.20  
20,5 cm/8"  
38 x 18 mm



**GREEN**  
18.348.22  
22,5 cm/8¾"  
22 x 22 mm



**KIRSCH**  
20 cm/8"

Mucoperiosthaken  
Diagonal Cheek Retractors for lateral region

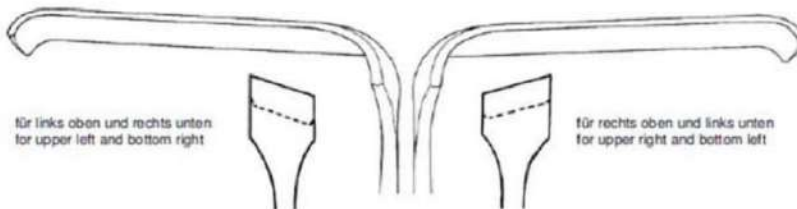

für links oben und rechts unten  
for upper left and bottom right

**48.588.20**  
60 x 10 mm

für rechts oben und links unten  
for upper right and bottom left

**48.589.20**  
60 x 10 mm

**Orthopedic**



**TUFFRO**

The Mangalm Surgical Co.

**Orthopedic**



**WARD**  
48.590.15  
15,5 cm/6"



**BOWDLER-HENRY**  
48.590.70  
16 cm/6 1/4"



**KAY (AUSTIN)**  
48.590.73



Lateral Ramus-Haken  
lateral vertical ramus retractor



**MUNRO**  
16 cm/6 1/4"

48.591.20 20 x 80 mm
48.591.25 25 x 80 mm
48.591.30 30 x 80 mm
48.591.35 35 x 80 mm





**TUFFRO**

The Mangalm Surgical Co.



OBWEGESER  
48.595.22  
22 cm/8 3/4"

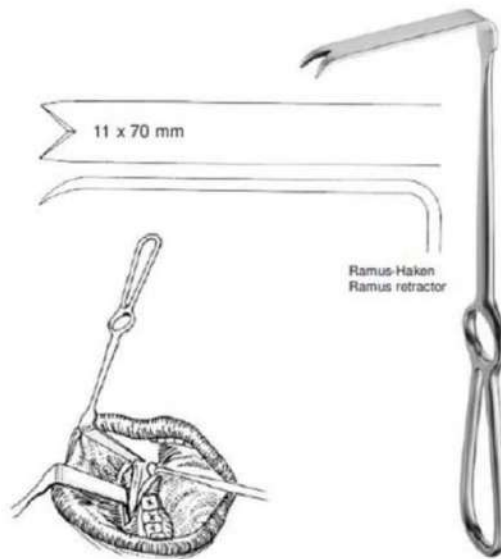

OBWEGESER  
48.597.22  
22 cm/8 3/4"

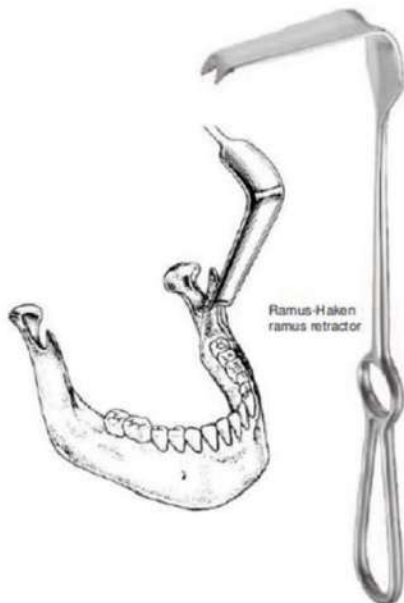

OBWEGESER  
24.5 cm/9 3/4"

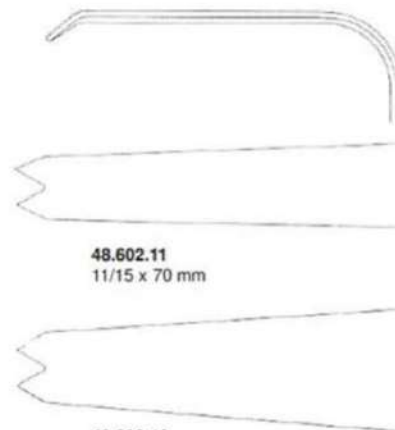

**Orthopedic**



**TUFFRO**

The Mangalm Surgical Co.



OBWEGESER  
48.595.22  
22 cm/8 3/4"

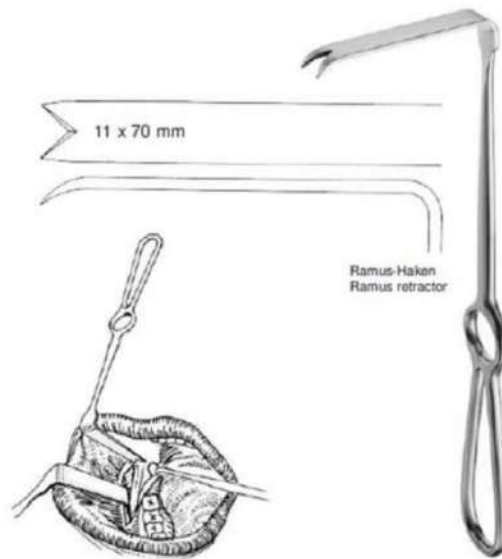

OBWEGESER  
48.597.22  
22 cm/8 3/4"

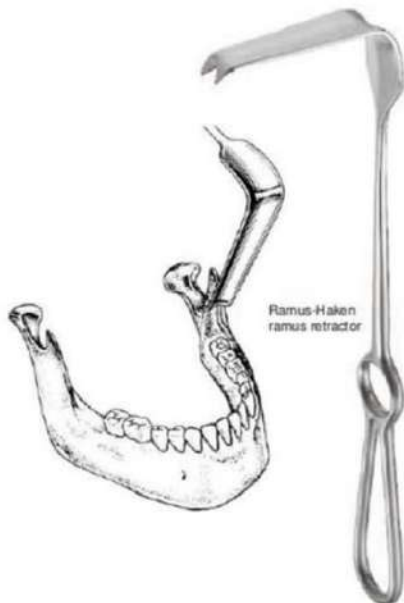

OBWEGESER  
24.5 cm/9 3/4"



**Orthopedic**



**TUFFRO**

The Mangalm Surgical Co.

**Orthopedic**



Weichteilhaken  
Soft Tissue Retractor

**OBWEGESER**  
21,5 cm/8½"

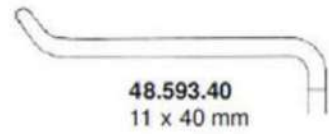

**48.593.40**  
11 x 40 mm

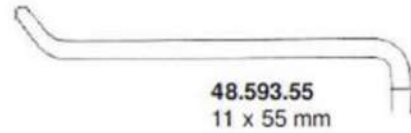

**48.593.55**  
11 x 55 mm



**48.593.80**  
16 x 80 mm



**TUFFRO**

The Mangalm Surgical Co.



Kinnhalter  
Chin Retractor



16,5 mm

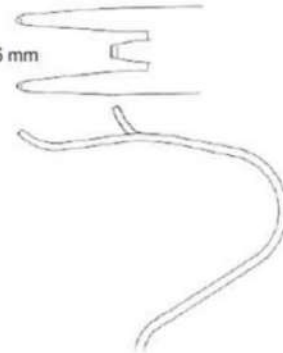

OBWEGESER  
48.601.16  
16 cm/6¼"

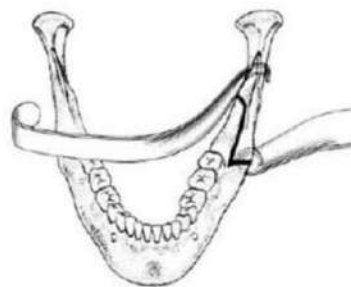

Progenierinnen  
Channel Retractors



48.603.08  
8 mm

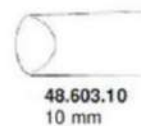

48.603.10  
10 mm

OBWEGESER  
16,5 cm/6½"

**Orthopedic**



**TUFFRO**

The Mangalm Surgical Co.

**Orthopedic**

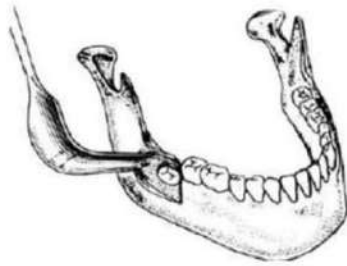

Weisheitszahn-Haken  
Third Molar Retractor



15/22 x 70 mm

OBWEGESER  
48.603.00  
24 cm/9½"

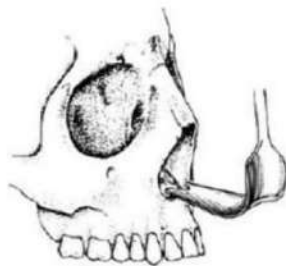

Spina nasale-Haken  
Nasal Spine Retractor

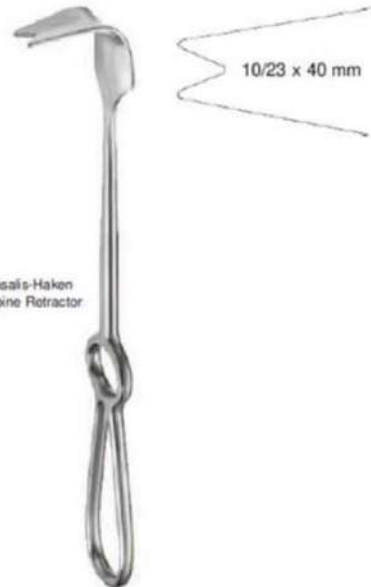

10/23 x 40 mm

OBWEGESER  
48.604.24  
24,5 cm/9½"



**TUFFRO**

The Mangalm Surgical Co.

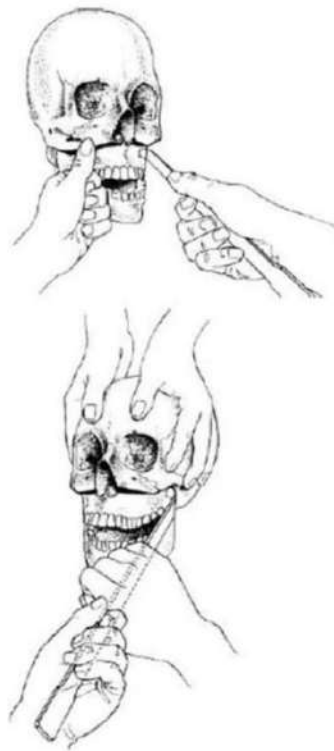

Maxilla-Mobilisator  
Maxilla Mobilizer

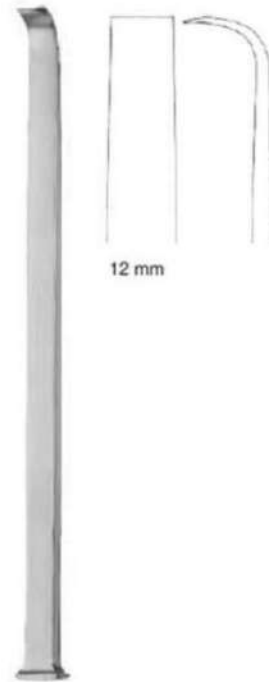

12 mm

OBWEGESER  
48.605.23  
23 cm/9"

48.507.01  
9 mm  
rechts  
right



Oberkiefer-Mobilisierhaken  
Retromaxillary levers

48.507.02  
9 mm  
links  
left

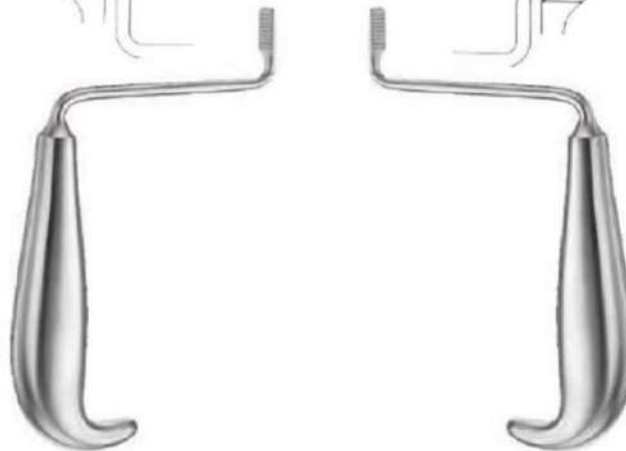
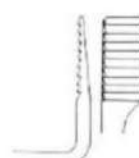

TESSIER  
15 cm/6"

**Orthopedic**



**TUFFRO**

The Mangalm Surgical Co.

**Orthopedic**

abwärtsgebogen  
bent downwards

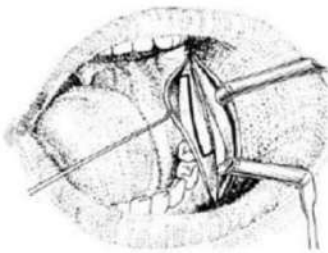

**OBWEGESER**  
24 cm/9½"

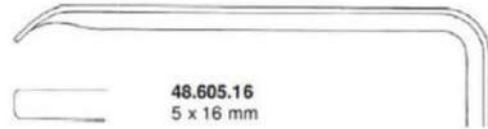

**48.605.16**  
5 x 16 mm

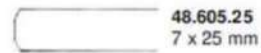

**48.605.25**  
7 x 25 mm



**48.605.35**  
10 x 35 mm



**48.605.42**  
10 x 42 mm



**48.605.55**  
12 x 55 mm



**48.605.70**  
14 x 70 mm



**48.605.80**  
16 x 80 mm

aufwärtsgebogen  
bent upwards

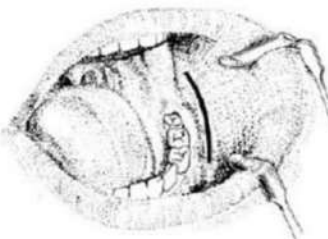

**OBWEGESER**  
24 cm/9½"

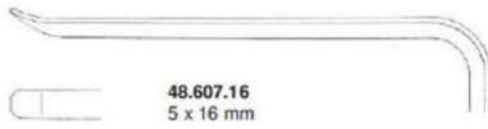

**48.607.16**  
5 x 16 mm



**48.607.25**  
7 x 25 mm



**48.607.35**  
10 x 35 mm



**48.607.42**  
10 x 42 mm



**48.607.55**  
12 x 55 mm



**48.607.70**  
14 x 70 mm



**48.607.80**  
16 x 80 mm



**TUFFRO**

The Mangalm Surgical Co.



Biegsame Spatel  
konisch  
Malleable retractors  
conical

**48.781.10**  
10 - 12 mm  
Fig. A

**48.781.15**  
15 - 17 mm  
Fig. B

**48.781.20**  
20 - 22 mm  
Fig. C

**48.781.00**  
Fig. A/B/C  
Satz von 3  
Set of 3

TESSIER  
22 cm/8<sup>3</sup>/<sub>4</sub>"

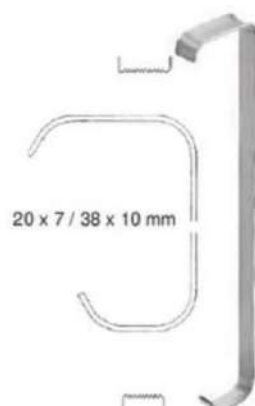

20 x 7 / 38 x 10 mm

TESSIER  
**48.783.01**  
15 cm/6"



**48.785.01**  
20 x 12 / 38 x 16 mm

**48.785.02**  
30 x 12 / 35 x 16 mm

**48.785.03**  
35 x 12 / 45 x 16 mm

**48.785.00**  
Satz von 3  
Set of 3

TESSIER  
15,5 cm/6"



50 x 12 / 70 x 16 mm

TESSIER  
**48.787.50**  
15,5 cm/6"



**48.795.10**  
10 mm



**48.795.17**  
17,5 mm



**48.795.20**  
20 mm

Sattelhäkchen  
schwarzverchromt  
Saddle Hooklets  
black chrome-plated

TESSIER  
14,5 cm/5<sup>3</sup>/<sub>4</sub>"

Orthopedic





**TUFFRO**

The Mangalm Surgical Co.

**Orthopedic**



**TESSIER**  
16 cm/6¼"

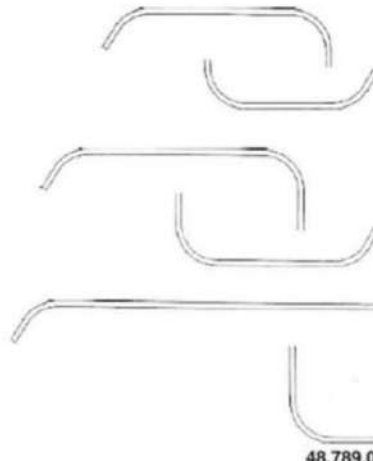

**48.789.30**  
30 x 12 / 35 x 16 mm

**48.789.35**  
35 x 12 / 45 x 16 mm

**48.789.50**  
50 x 12 / 70 x 16 mm

**48.789.00**  
Satz von 3  
Set of 3



**48.791.01**  
Fig. 1  
8 mm



**48.791.02**  
Fig. 2  
10 mm



**48.791.03**  
Fig. 3  
7 mm



**48.791.05**  
Fig. 5  
8 mm



**48.791.06**  
Fig. 6  
12 mm



**48.791.04**  
Fig. 4  
10 mm



**TESSIER**  
12,5 cm/5"



**TESSIER**  
12,5 cm/5"



**TUFFRO**

The Mangalm Surgical Co.

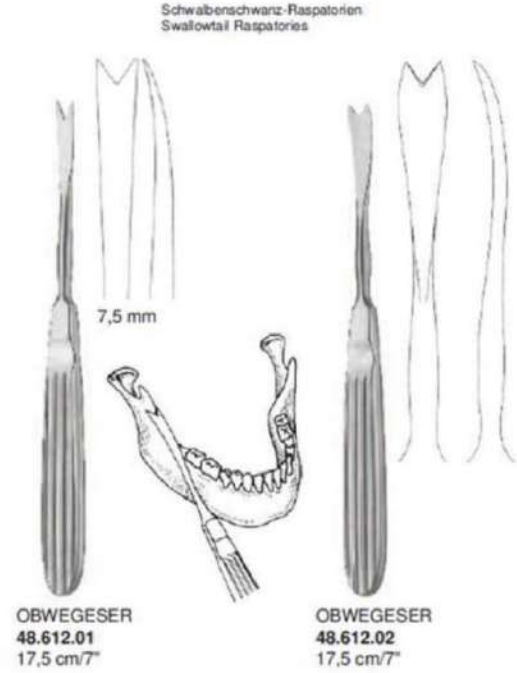
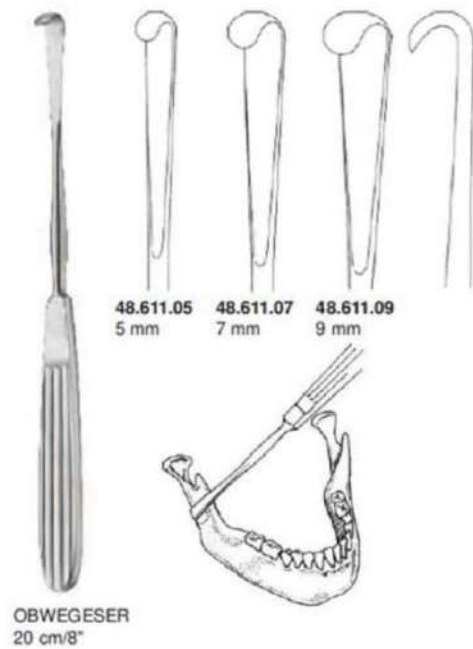
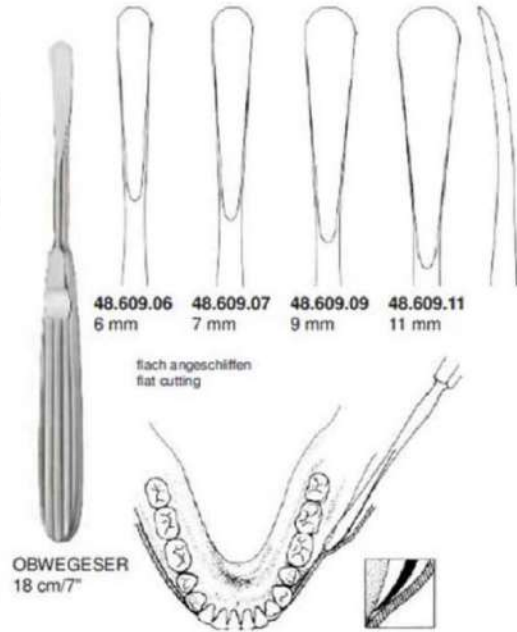
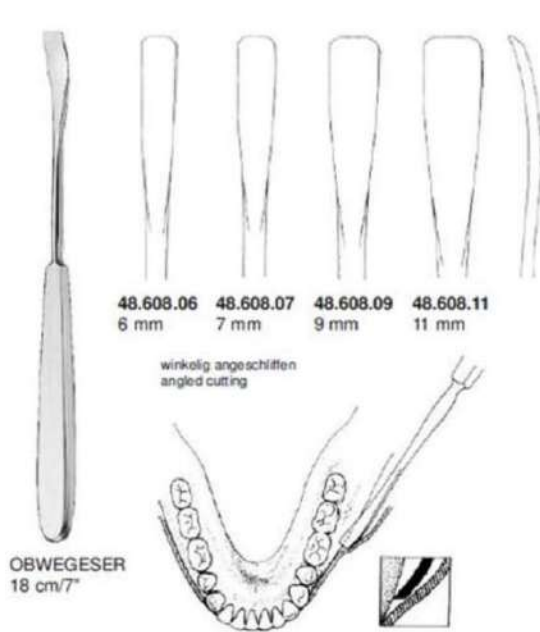

**Orthopedic**



**TUFFRO**

The Mangalm Surgical Co.

**Orthopedic**

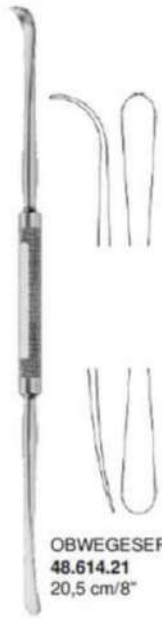

**OBWEGESER**  
**48.614.21**  
20,5 cm/8"



**OBWEGESER**  
**48.614.21**  
21 cm/8¼"

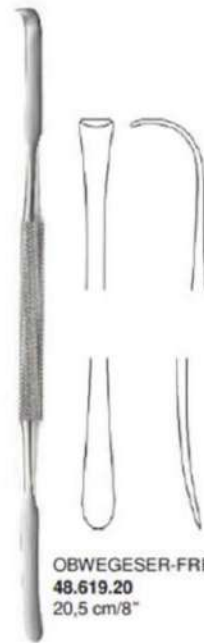

**OBWEGESER-FREER**  
**48.619.20**  
20,5 cm/8"

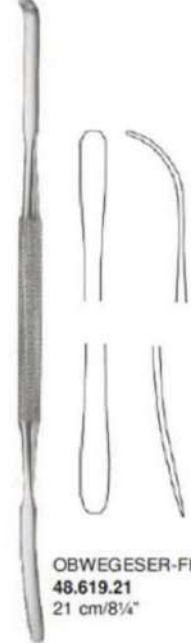

**OBWEGESER-FREER**  
**48.619.21**  
21 cm/8¼"



5,5 mm  
scharf  
sharf

10 mm  
scharf  
sharf

**OBWEGESER**  
**48.621.10**  
20,5 cm/8"



5 mm  
scharf  
sharf

**48.623.01**  
leicht gebogen  
slightly curved

**48.623.02**  
stark gebogen  
strongly curved

5 mm  
stumpf  
blunt

**SALZBURG**  
24,5 cm/10"

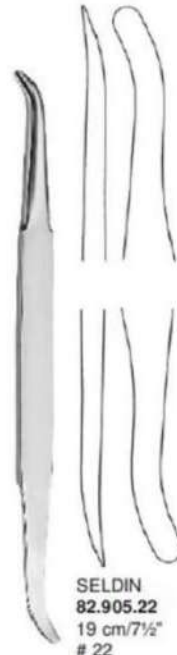

**SELDIN**  
**82.905.22**  
19 cm/7½"  
# 22

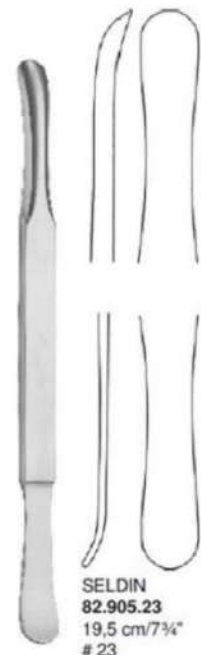

**SELDIN**  
**82.905.23**  
19,5 cm/7¾"  
# 23



**TUFFRO**

The Mangalm Surgical Co.

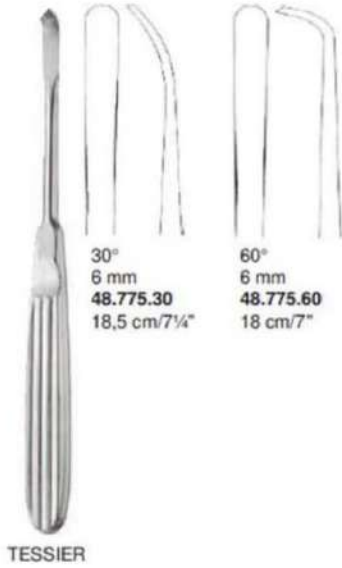

30°  
6 mm  
48.775.30  
18,5 cm/7¼"

60°  
6 mm  
48.775.60  
18 cm/7"

TESSIER

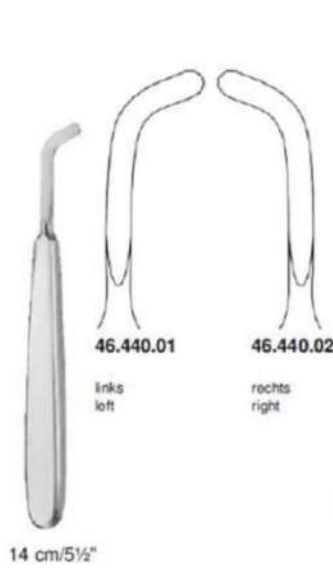

46.440.01

links  
left

46.440.02

rechts  
right

14 cm/5½"

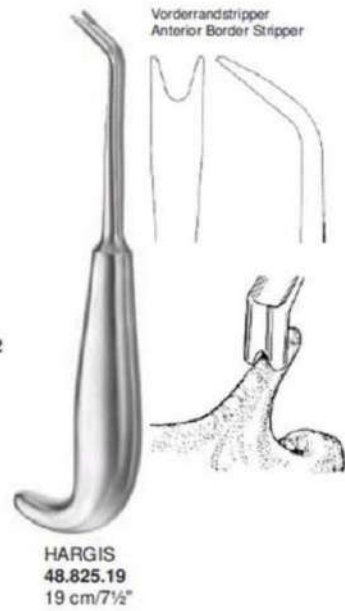

Vorderrandstripper  
Anterior Border Stripper

HARGIS  
48.825.19  
19 cm/7½"

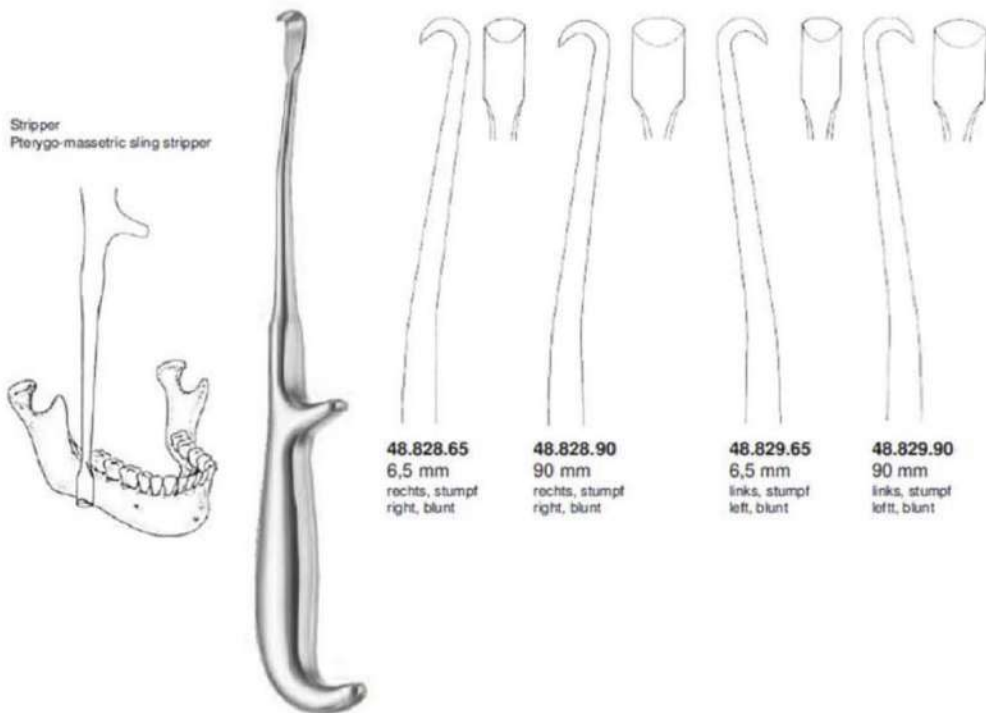

Stripper  
Pterygo-massetric sling stripper

48.828.65  
6,5 mm  
rechts, stumpf  
right, blunt

48.828.90  
90 mm  
rechts, stumpf  
right, blunt

48.829.65  
6,5 mm  
links, stumpf  
left, blunt

48.829.90  
90 mm  
links, stumpf  
left, blunt

Orthopedic



**TUFFRO**

The Mangalm Surgical Co.

**Orthopedic**

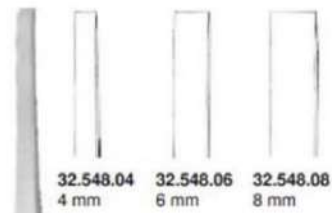

32.548.04 4 mm  
32.548.06 6 mm  
32.548.08 8 mm

**MARCHAC**  
18,5 cm/7¼"



32.549.06  
6 mm  
gebogen  
curved

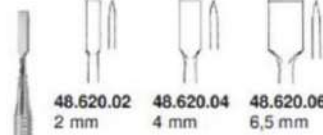

48.620.02 2 mm  
48.620.04 4 mm  
48.620.06 6,5 mm

**OBWEGESER**  
15 cm/6"

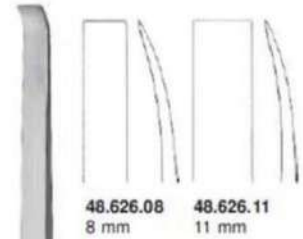

48.626.08 8 mm  
48.626.11 11 mm

Tuber maxillae-Ostotome  
Ostotomes for Maxillary Tuber

**OBWEGESER**  
23,5 cm/9¼"

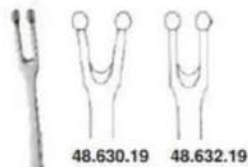
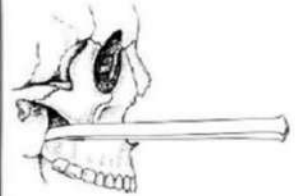

48.630.19 48.632.19

**OBWEGESER**  
18,5 cm/7¼"

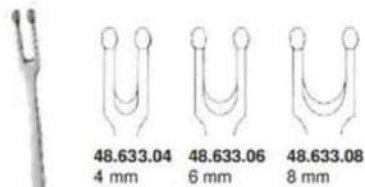

48.633.04 4 mm  
48.633.06 6 mm  
48.633.08 8 mm

Septum-Ostotome  
Nasal/Septonasal-Ostotomes

**OBWEGESER**  
18,5 cm/7¼"

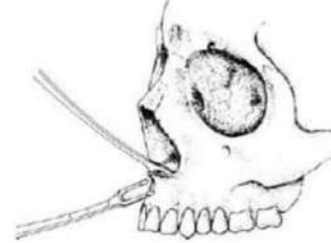



**TUFFRO**

The Mangalm Surgical Co.

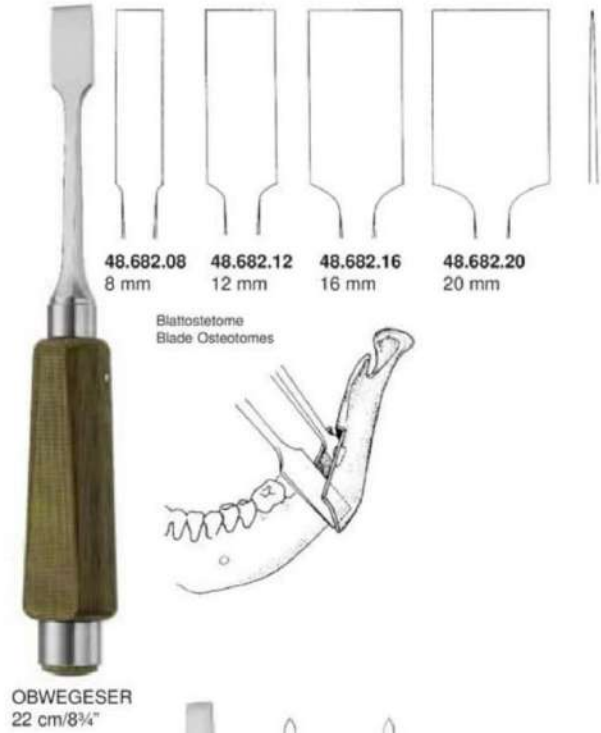

Orthopedic



**TUFFRO**

The Mangalm Surgical Co.

**Orthopedic**

Aveolarfortsatz-Osteotome  
Aveolar Process Osteotomes

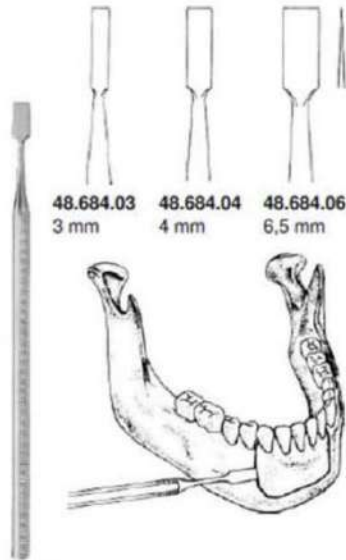

**OBWEGESER**  
15,5 cm/6"

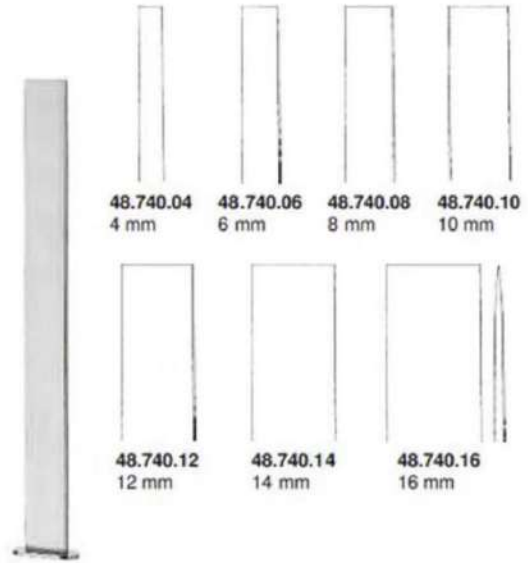

**DAUTREY-MUNRO**  
16 cm/6 1/4"

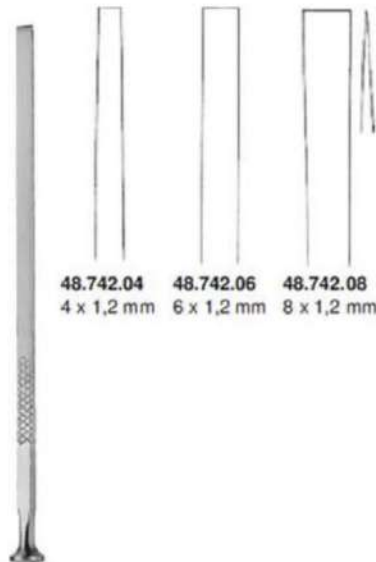

**EPKER**  
18 cm/7"

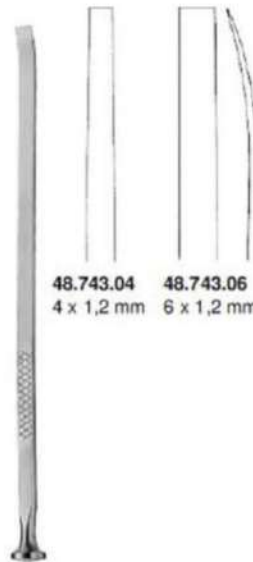

**EPKER**  
18 cm/7"

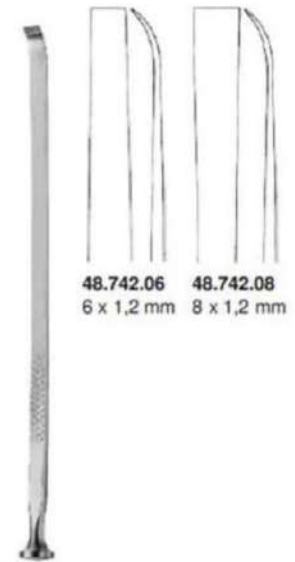

**EPKER**  
18 cm/7"

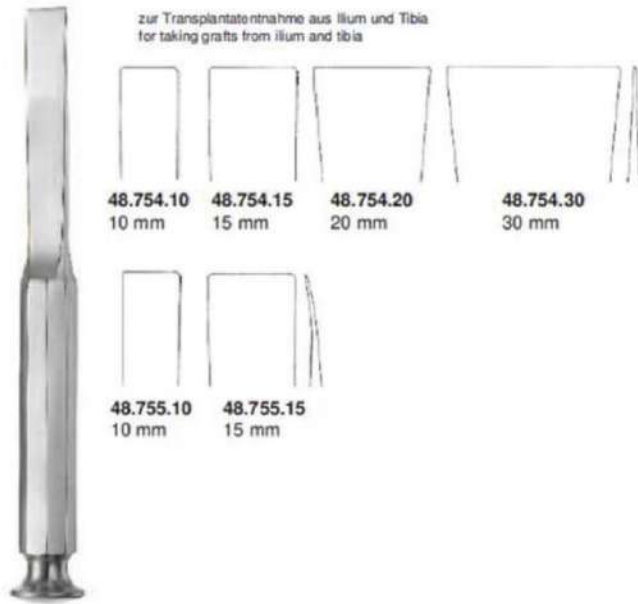

zur Transplantatentnahme aus Ilium und Tibia  
for taking grafts from ilium and tibia

48.754.10 10 mm	48.754.15 15 mm	48.754.20 20 mm	48.754.30 30 mm
48.755.10 10 mm	48.755.15 15 mm		

**TESSIER**  
20 cm/7 $\frac{1}{4}$ "

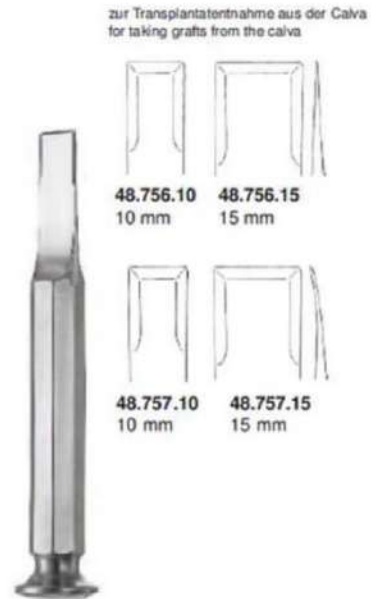

zur Transplantatentnahme aus der Calva  
for taking grafts from the calva

48.756.10 10 mm	48.756.15 15 mm
48.757.10 10 mm	48.757.15 15 mm

**TESSIER**  
16 cm/6 $\frac{1}{4}$ "



Kopf  
head  
ø 27 mm  
  
Gewicht  
Weight  
140 g

**HAJEK**  
32.687.22  
22 cm/8 $\frac{1}{4}$ "



Kopf  
head  
ø 30 mm  
  
Gewicht  
Weight  
300 g

**COTTLE**  
32.689.24  
19 cm/7 $\frac{1}{2}$ "



Kopf  
head  
ø 25 mm  
  
Gewicht  
Weight  
135 g

**32.691.14**  
18,5 cm/7 $\frac{1}{4}$ "





**TUFFRO**

The Mangalm Surgical Co.

**Orthopedic**



Kopf  
head  
ø 20 mm  
  
Gewicht  
Weight  
140 g

**WILLIGER**  
**32.695.14**  
16,5 cm/6½"



bleigefüllt  
lead filled

Kopf  
head  
ø 22 mm  
  
Gewicht  
Weight  
155 g

**32.696.19**  
19 cm/7½"

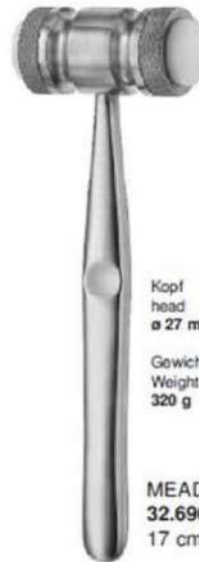

Kopf  
head  
ø 27 mm  
  
Gewicht  
Weight  
320 g

**MEAD**  
**32.696.32**  
17 cm/6¾"



**32.697.02**

Ersatzbacken (Paar)  
Spare Facings (pair)  
Kunststoff (Nylon)  
plastic (nylon)



**TUFFRO**

The Mangalm Surgical Co.



**32.386.20**  
20 cm/8"



**DINGMANN**  
**32.407.19**  
19 cm/7½"



**JETER-VAN SICKELS**  
18 cm/7"

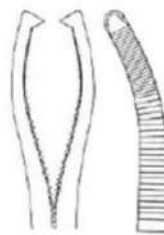

**32.408.01**  
leichtes Modell  
light pattern

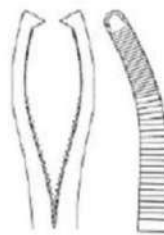

**32.408.02**  
Kräftiges Modell  
heavy pattern

für sagittalen Split  
for sagittal split procedure

**Orthopedic**



**TUFFRO**

The Mangalm Surgical Co. .

**Orthopedic**

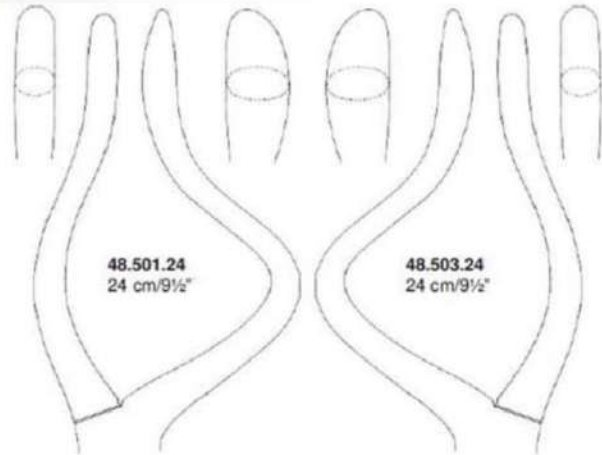

48.501.24  
24 cm/9½"

48.503.24  
24 cm/9½"



ROWE  
links  
left

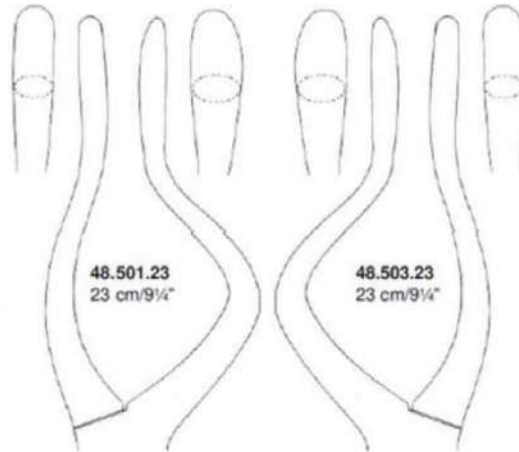

48.501.23  
23 cm/9¼"

48.503.23  
23 cm/9¼"



ROWE  
rechts  
right

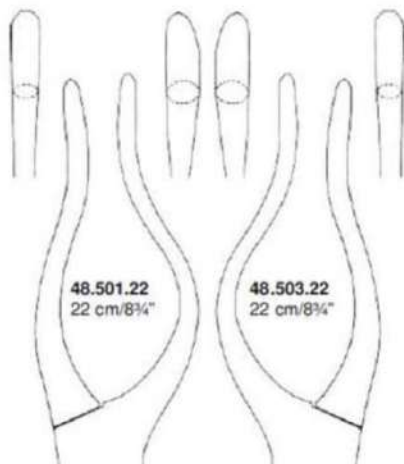

48.501.22  
22 cm/8¾"

48.503.22  
22 cm/8¾"



**TUFFRO**

The Mangalm Surgical Co.

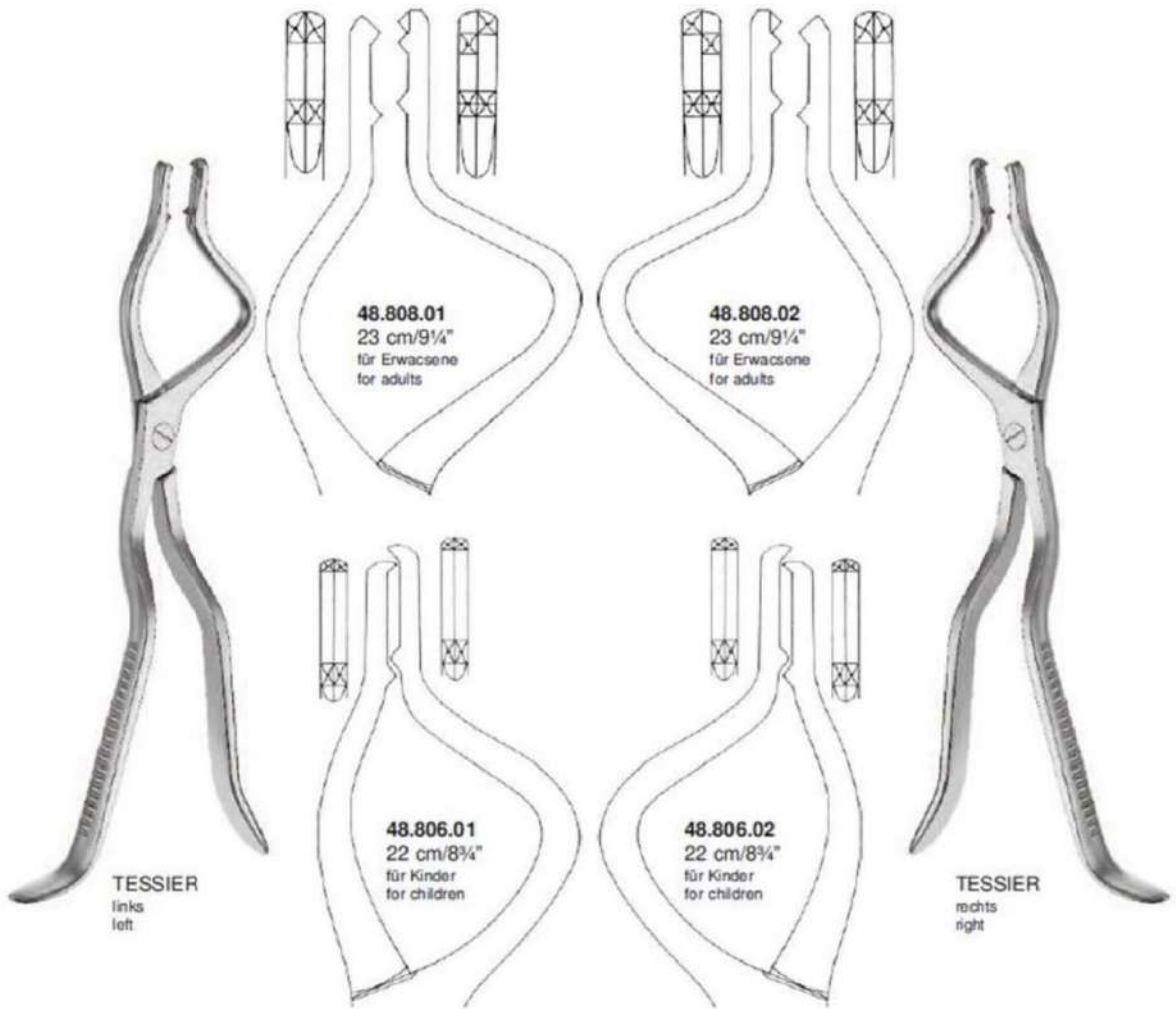

**Orthopedic**



**TUFFRO**

The Mangalm Surgical Co.

**Orthopedic**

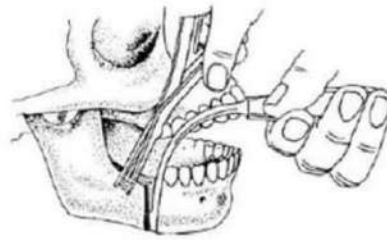

Knochenformzange  
Bone Contouring Forceps

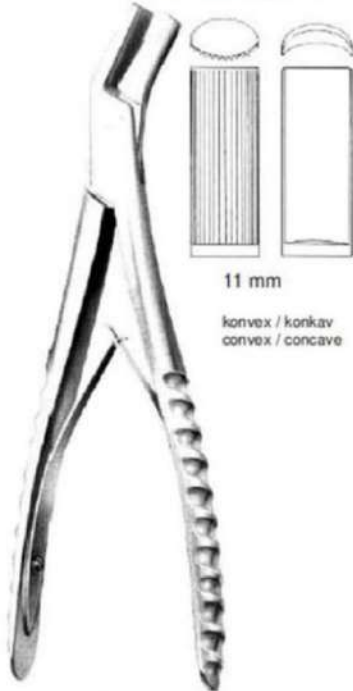

11 mm

konvex / konkav  
convex / concave

TESSIER  
48.799.22  
22 cm/8 3/4"

Spreizzange  
Spreading Forceps



7 mm

TESSIER  
48.802.18  
17,5 cm/7"

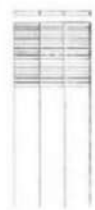

12 mm

48.838.20  
ohne Sperrer  
without ratchet

48.840.20  
mit Sperrer  
with ratchet



SMITH  
48.838.20  
23,5 cm/9 1/4"



**TUFFRO**

The Mangalm Surgical Co.

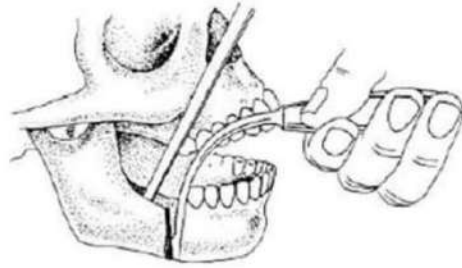

9 mm  
rechts  
right



9 mm  
links  
left



SMITH  
48.835.01  
18,5 cm/7¼"



SMITH  
48.835.02  
18,5 cm/7¼"

**Orthopedic**



**TUFFRO**

The Mangalm Surgical Co.



Draht  
Ligature wire

weich, Rolle mit 10 m  
soft, coil of 10 m

- |                              |                              |
|------------------------------|------------------------------|
| <b>33.530.02</b><br>ø 0,2 mm | <b>33.530.08</b><br>ø 0,8 mm |
| <b>33.530.03</b><br>ø 0,3 mm | <b>33.530.09</b><br>ø 0,9 mm |
| <b>33.530.04</b><br>ø 0,4 mm | <b>33.530.10</b><br>ø 1,0 mm |
| <b>33.530.05</b><br>ø 0,5 mm | <b>33.530.12</b><br>ø 1,2 mm |
| <b>33.530.06</b><br>ø 0,6 mm | <b>33.530.15</b><br>ø 1,5 mm |
| <b>33.530.07</b><br>ø 0,7 mm |                              |



Drahtbögen  
Arch bars

ERICH  
48.529.00

Rolle/1 m  
Roll/1 m



ERICH  
48.529.13  
14 cm/5½"

Drahtösenklemme  
Wire loop forceps



OBWEGESER  
48.650.15  
15,5 cm/6¼"

**Orthopedic**

Mit TC-Einsätzen  
TC Lined



**BARMESH**  
48.529.13  
13,5 cm/5½"



**33.533.01**

**33.533.02**

**33.533.03**

parallel fassend  
parallel grip

18 cm/7"



**TUFFRO**

The Mangalm Surgical Co.



**33.601.15**  
15 cm/6"



kräftiges Modell  
heavy pattern

**BERRY**  
**33.601.19**  
19 cm/7½"



Eine Schneide gezahnt  
One toothed cutting edge

**08.835.12**  
12 cm/4¾"



**33.545.16**  
17 cm/6¾"



**33.545.22**  
22,5 cm/8¾"

**Orthopedic**





**TUFFRO**

The Mangalm Surgical Co.



Behälter mit Instrumentarium  
Case with Instruments

33.482.00

Behälter ohne Instrumentarium  
Case without Instruments

33.482.01

Einsätze  
Screw Driver Shafts



Schraubenziehergriff  
Screwdriver Handle

33.482.02  
14,5 cm / 5½"



33.482.03  
14,0 cm / 5½"



33.482.06  
14,0 cm / 5½"



33.482.09  
14,0 cm / 5½"



33.482.10  
14,0 cm / 5½"



JACOBS  
Universalbohrfutter  
Universal Chuck

33.482.13  
7,5 mm / 3"



33.482.18  
14,0 cm / 5½"



33.482.19  
14,0 cm / 5½"

Orthopedic



**TUFFRO**

The Mangalm Surgical Co.

Tamponstopfer  
Gauze Packer



**LUNIATSCHEK**  
50.151.19  
19 cm/7½"

Unterkieferahln  
Maxillary Awls



**OBWEGESSER**  
48.647.13  
13 cm/5"



**OBWEGESSER**  
48.647.15  
15 cm/6"



**OBWEGESSER**  
48.647.17  
17,5 cm/7"



Jochbogenahln  
Zygomatic Arch Awl



**OBWEGESSER**  
48.679.24  
24 cm/9½"

gerade  
straight



**KELSEY FRY**  
48.636.15  
15 cm/6"

gebogen  
curved



**KELSEY FRY**  
48.637.18  
18 cm/7"



**Orthopedic**



**TUFFRO**

The Mangalm Surgical Co.



# Orthopedic Implants



**TUFFRO**

The Mangalm Surgical Co.



Länge mm Length mm	Artikel Nr. Cat. No.
6	<b>36.200.06</b>
7	<b>36.200.07</b>
8	<b>36.200.08</b>
9	<b>36.200.09</b>
10	<b>36.200.10</b>
11	<b>36.200.11</b>
12	<b>36.200.12</b>
14	<b>36.200.14</b>
16	<b>36.200.16</b>
18	<b>36.200.18</b>
20	<b>36.200.20</b>



Länge mm Length mm	Artikel Nr. Cat. No.
6	<b>36.201.06</b>
8	<b>36.201.08</b>
10	<b>36.201.10</b>
12	<b>36.201.12</b>
14	<b>36.201.14</b>
16	<b>36.201.16</b>
18	<b>36.201.18</b>
20	<b>36.201.20</b>
22	<b>36.201.22</b>
24	<b>36.201.24</b>
26	<b>36.201.26</b>
28	<b>36.201.28</b>
30	<b>36.201.30</b>
32	<b>36.201.32</b>
34	<b>36.201.34</b>
36	<b>36.201.36</b>
38	<b>36.201.38</b>



Länge mm Length mm	Artikel Nr. Cat. No.
6	<b>36.202.06</b>
8	<b>36.202.08</b>
10	<b>36.202.10</b>
12	<b>36.202.12</b>
14	<b>36.202.14</b>
16	<b>36.202.16</b>
18	<b>36.202.18</b>
20	<b>36.202.20</b>
22	<b>36.202.22</b>
24	<b>36.202.24</b>
26	<b>36.202.26</b>
28	<b>36.202.28</b>
30	<b>36.202.30</b>
32	<b>36.202.32</b>
34	<b>36.202.34</b>
36	<b>36.202.36</b>
38	<b>36.202.38</b>
40	<b>36.202.40</b>

**Orthopedic**



**TUFFRO**

The Mangalm Surgical Co.

**Orthopedic**



3,5 mm

Länge mm Length mm	Artikel Nr. Cat. No.
8	36.204.08
10	36.204.10
12	36.204.12
14	36.204.14
16	36.204.16
18	36.204.18
20	36.204.20
22	36.204.22
24	36.204.24
26	36.204.26
28	36.204.28
30	36.204.30
32	36.204.32
34	36.204.34
36	36.204.36
40	36.204.40
45	36.204.45
50	36.204.50
55	36.204.55
60	36.204.60
65	36.204.65
70	36.204.70
75	36.204.75
80	36.204.80
85	36.204.85
90	36.204.90
95	36.204.95



**TUFFRO**

The Mangalm Surgical Co.



3,5 mm

Länge mm Length mm	Artikel Nr. Cat. No.
8	36.206.08
10	36.206.10
12	36.206.12
14	36.206.14
16	36.206.16
18	36.206.18
20	36.206.20
22	36.206.22
24	36.206.24
26	36.206.26
28	36.206.28
30	36.206.30
32	36.206.32
34	36.206.34
36	36.206.36
40	36.206.40
45	36.206.45
50	36.206.50
55	36.206.55
60	36.206.60
65	36.206.65



4,0 mm

Länge mm Length mm	Gewindelänge mm Length of thread mm	Artikel Nr. Cat. No.
10	5	36.207.10
12	5	36.207.12
14	5	36.207.14
16	6	36.207.16
18	7	36.207.18
20	8	36.207.20
22	9	36.207.22
24	10	36.207.24
26	12	36.207.26
28	14	36.207.28
30	14	36.207.30
35	14	36.207.35
40	14	36.207.40
45	15	36.207.45
50	15	36.207.50

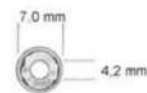

Unterlagscheibe  
Washer

36.219.98

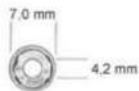

Unterlagscheibe  
Washer

36.219.98

Orthopedic



**TUFFRO**

The Mangalm Surgical Co.

**Orthopedic**



4,5 mm

Länge mm Length mm	Artikel Nr. Cat. No.
14	36.214.14
16	36.214.16
18	36.214.18
20	36.214.20
22	36.214.22
24	36.214.24
26	36.214.26
28	36.214.28
30	36.214.30
32	36.214.32
34	36.214.34
36	36.214.36
38	36.214.38
40	36.214.40
42	36.214.42
44	36.214.44
46	36.214.46
48	36.214.48
50	36.214.50
52	36.214.52
54	36.214.54
56	36.214.56
60	36.214.60
62	36.214.62
64	36.214.64
70	36.214.70
80	36.214.80



Mutter  
Nut

36.219.96



Schraubenschlüssel  
Wrench

36.608.80



**TUFFRO**

The Mangalm Surgical Co.



Unterlagscheibe  
Washer

36.219.99

Länge mm Length mm	Artikel Nr. Cat. No.
20	36.215.20
25	36.215.25
30	36.215.30
35	36.215.35
40	36.215.40
45	36.215.45
50	36.215.50
55	36.215.55
60	36.215.60
65	36.215.65
70	36.215.70
80	36.215.80

**Orthopedic**





**TUFFRO**

The Mangalm Surgical Co.

**Orthopedic**

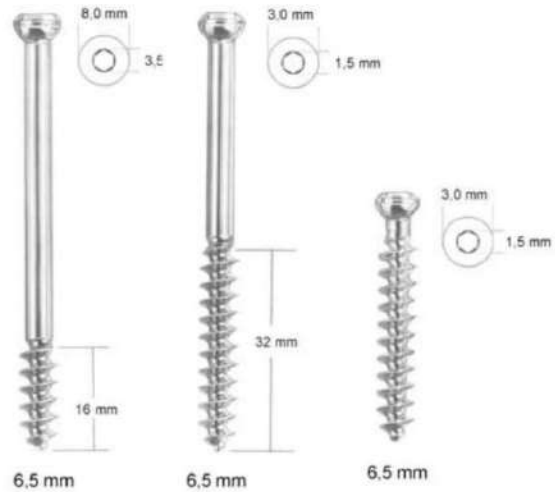

Unterlagscheibe  
Washer

**36.219.99**

Länge mm Length mm	Artikel Nr. Cat. No.	Artikel Nr. Cat. No.	Artikel Nr. Cat. No.
25			36.218.25
30	36.216.30		36.218.30
35	36.216.35		36.218.35
40	36.216.40		36.218.40
45	36.216.45	36.217.45	36.218.45
50	36.216.50	36.217.50	36.218.50
55	36.216.55	36.217.55	36.218.55
60	36.216.60	36.217.60	36.218.60
65	36.216.65	36.217.65	36.218.65
70	36.216.70	36.217.70	36.218.70
75	36.216.75	36.217.75	36.218.75
80	36.216.80	36.217.80	36.218.80
85	36.216.85	36.217.85	36.218.85
90	36.216.90	36.217.90	36.218.90
95	36.216.95	36.217.95	36.218.95
100	36.216.00	36.217.00	36.218.00
105	36.216.05	36.217.05	36.218.05
110	36.216.10	36.217.10	36.218.10
115	36.216.15	36.217.15	
120	36.216.20	36.217.20	



**TUFFRO**

The Mangalm Surgical Co.

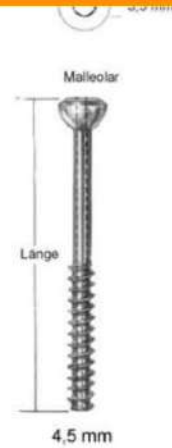
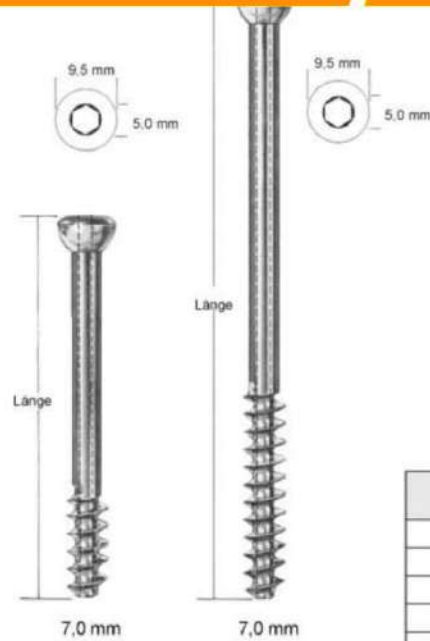

Länge mm Length mm	Gewindelänge mm Thread Length mm	Artikel Nr. Cat. No.
25	12	36.115.25
30	15	36.115.30
35	18	36.115.35
40	20	36.115.40
45	22	36.115.45
50	24	36.115.50
55	26	36.115.55

Länge mm Length mm	Artikel Nr. Cat. No.	Artikel Nr. Cat. No.
25	36.116.25	
30	36.116.30	
35	36.116.35	
40	36.116.40	36.118.40
45	36.116.45	36.118.45
50	36.116.50	36.118.50
55	36.116.55	36.118.55
60	36.116.60	36.118.60
65	36.116.65	36.118.65
70	36.116.70	36.118.70
75	36.116.75	36.118.75
80	36.116.80	36.118.80
85	36.116.85	36.118.85
90	36.116.90	36.118.90
95	36.116.95	36.118.95
100	36.117.00	36.119.00
105	36.117.05	36.119.05
110	36.117.10	36.119.10
115	36.117.15	36.119.15
120	36.117.20	36.119.20

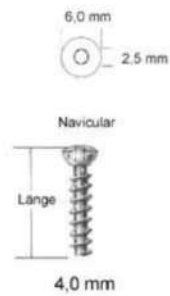

Länge mm Length mm	Gewindelänge mm Thread Length mm	Artikel Nr. Cat. No.
10	4	36.107.10
12	4	36.107.12
14	4	36.107.14
16	5	36.107.16
18	6	36.107.18
20	7	36.107.20
22	8	36.107.22
24	9	36.107.24
26	10	36.107.26
28	10	36.107.28
30	10	36.107.30



Unterlagscheibe für Hohlschrauben  
Washer for cannulated screws

- 36.120.13    ø 13 mm
- 36.120.16    ø 16 mm
- 36.120.19    ø 19 mm

**Orthopedic**



**TUFFRO**

The Mangalm Surgical Co.

**Orthopedic**



Führungsspieß  $\varnothing$  1,6 mm  
für Hohlschrauben  $\varnothing$  7,0 mm  
Guide wire  $\varnothing$  1,6 mm  
for hollow screws  $\varnothing$  7,0 mm

**33.722.10** 100 mm  
**33.722.15** 150 mm  
**33.722.20** 200 mm



Führungsspieß  $\varnothing$  1,0 mm für  
Malleolar- und Navicularschrauben  
Guide wire  $\varnothing$  1,0 mm for  
Malleolar and Navicular screws

**33.724.10** 100 mm  
**33.724.15** 150 mm



Corticalfräser  
Cortex Reamer

**33.802.45**  $\varnothing$  4,5 mm  
**33.802.70**  $\varnothing$  7,0 mm



Flachbohrer  $\varnothing$  5,0 mm  
Flat Drill  $\varnothing$  5,0 mm

**33.810.05**



Gewindeschneider  $\varnothing$  4,5 mm -  $\varnothing$  7,0 mm  
Tap  $\varnothing$  4,5 mm -  $\varnothing$  7,0 mm

**33.812.45**  $\varnothing$  4,5 mm  
**33.812.70**  $\varnothing$  7,0 mm

**TUFFRO**

The Mangalm Surgical Co.



Beide Plattendenen mit Nut zum Einhängen des Plattenspanners  
Both end are notched to hold tension device

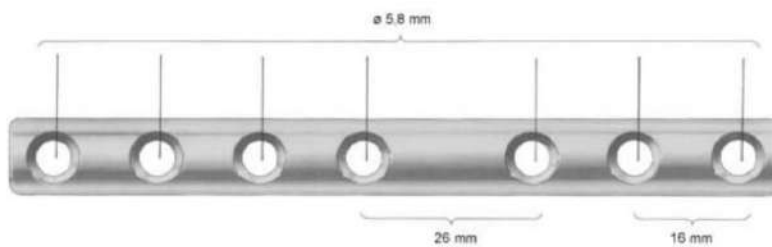
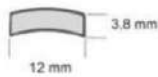

Länge mm Length mm	Lochanzahl No. of holes	Artikel Nr. Cat. No.
39	2	36.223.02
55	3	36.223.03
71	4	36.223.04
87	5	36.223.05
103	6	36.223.06
119	7	36.223.07
135	8	36.223.08
151	9	36.223.09
167	10	36.223.10
183	11	36.223.11
199	12	36.223.12
215	13	36.223.13
231	14	36.223.14
247	15	36.223.15
263	16	36.223.16
279	17	36.223.17
295	18	36.223.18

Passende Schrauben / Recommended Screws:

Kortikal ø 4,5 mm	36.214.14 - 36.214.80
Malleolar ø 4,5 mm	36.215.20 - 36.215.80
Spongiosa ø 6,5 mm	36.216.00 - 36.216.95
Cancelous ø 6,5 mm	36.217.00 - 36.217.95
	36.218.00 - 36.218.95

**Orthopedic**



**TUFFRO**

The Mangalm Surgical Co.

Orthopedic



Beide Plattenenden mit Nut zum Einhängen des Plattenspanners  
Both end are notched to hold tension device

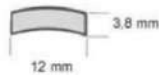

Länge mm Length mm	Lochanzahl No. of holes	Artikel Nr. Cat. No.
39	2	36.224.02
55	3	36.224.03
71	4	36.224.04
87	5	36.224.05
103	6	36.224.06
119	7	36.224.07
135	8	36.224.08
151	9	36.224.09
167	10	36.224.10
183	11	36.224.11
199	12	36.224.12
215	13	36.224.13
231	14	36.224.14
247	15	36.224.15
263	16	36.224.16

Passende Schrauben / Recommended Screws:	
Kortikal ø 4,5 mm	36.214.14 - 36.214.80
Malleolar ø 4,5 mm	36.215.20 - 36.215.80
Spongiosa ø 6,5 mm	36.216.00 - 36.216.95
Cancelous ø 6,5 mm	36.217.00 - 36.217.95
	36.218.00 - 36.218.95



**TUFFRO**

The Mangalm Surgical Co.



Beide Plattenenden mit Nut zum Einhängen des Plattenspanners  
Both end are notched to hold tension device

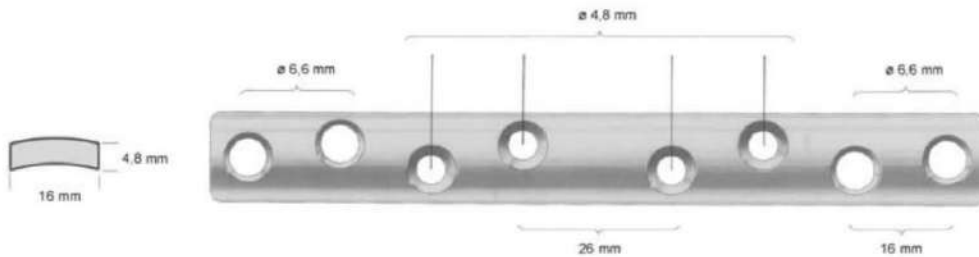

Länge mm Length mm	Locharzahl No. of holes	Artikel Nr. Cat. No.
103	6	36.225.06
119	7	36.225.07
135	8	36.225.08
151	9	36.225.09
167	10	36.225.10
183	11	36.225.11
199	12	36.225.12
215	13	36.225.13
231	14	36.225.14
247	15	36.225.15
263	16	36.225.16
295	18	36.225.18

Passende Schrauben / Recommended Screws:	
Kortikal ø 4,5 mm	36.214.14 - 36.214.80
Malleolar ø 4,5 mm	36.215.20 - 36.215.80
Spongiosa ø 6,5 mm	36.216.00 - 36.216.95
Cancellous ø 6,5 mm	36.217.00 - 36.217.95
	36.218.00 - 36.218.95

**Orthopedic**



**TUFFRO**

The Mangalm Surgical Co.

Orthopedic



Beide Plattendenen mit Nut zum Einhängen des Plattenspanners  
Both end are notched to hold tension device

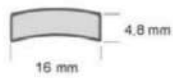

25 mm

16 mm

Länge mm Length mm	Lochanzahl No. of holes	Artikel Nr. Cat. No.
103	6	36.226.06
119	7	36.226.07
135	8	36.226.08
151	9	36.226.09
167	10	36.226.10
183	11	36.226.11
199	12	36.226.12
215	13	36.226.13
231	14	36.226.14
247	15	36.226.15
263	16	36.226.16
295	18	36.226.18

Passende Schrauben / Recommended Screws:

Kortikal ø 4,5 mm	36.214.14 - 36.214.80
Malleolar ø 4,5 mm	36.215.20 - 36.215.80
Spongiosa ø 6,5 mm	36.216.00 - 36.216.95
Cancelous ø 6,5 mm	36.217.00 - 36.217.95
	36.218.00 - 36.218.95



**TUFFRO**

The Mangalm Surgical Co.

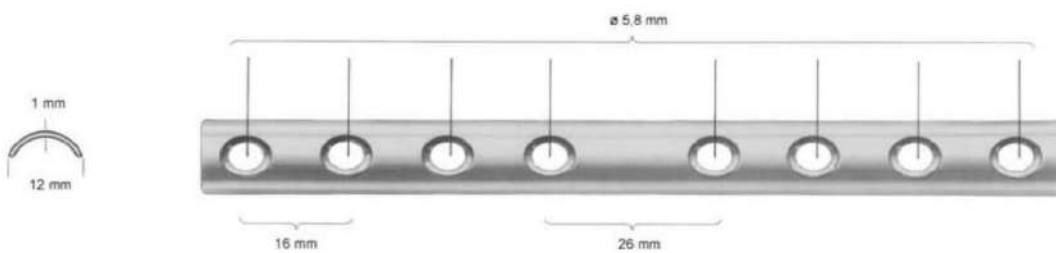

Länge mm Length mm	Lochanzahl No. of holes	Artikel Nr. Cat. No.
39	2	36.222.02
55	3	36.222.03
71	4	36.222.04
87	5	36.222.05
103	6	36.222.06
119	7	36.222.07
135	8	36.222.08
151	9	36.222.09
167	10	36.222.10
183	11	36.222.11
199	12	36.222.12

Passende Schrauben / Recommended Screws:	
Kortikal ø 4,5 mm	36.214.14 - 36.214.80
Malleolar ø 4,5 mm	36.215.20 - 36.215.80

**Orthopedic**





**TUFFRO**

The Mangalm Surgical Co.

**Orthopedic**



Länge mm Length mm	Lochanzahl No. of holes	Artikel Nr. Cat. No.
45	3 x 3	36.340.39
58	4 x 4	36.340.56
66	3 x 5	36.340.47
78	4 x 6	36.340.78



Länge mm Length mm	Lochanzahl No. of holes	Artikel Nr. Cat. No.
54	3 x 3	36.341.39
75	3 x 5	36.341.47

Passende Schrauben / Recommended Screws:

Kortikal ø 3,5 mm	36.204.10 - 36.204.95
-------------------	-----------------------



**TUFFRO**

The Mangalm Surgical Co.

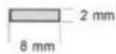

36.244.02 - 36.244.06



36.244.07 - 36.244.12

Länge mm Length mm	Lochanzahl No. of holes	Artikel Nr. Cat. No.
20	2	36.244.02
36	4	36.244.04
44	5	36.244.05
52	6	36.244.06
60	7	36.244.07
68	8	36.244.08
76	9	36.244.09
84	10	36.244.10
100	12	36.244.12

Passende Schrauben / Recommended Screws:	
Kortikal ø 2,7 mm	36.202.06 - 36.202.40



Länge mm Length mm	Lochanzahl No. of holes	Artikel Nr. Cat. No.
25	2	36.248.02
37	3	36.248.03
49	4	36.248.04
61	5	36.248.05
73	6	36.248.06
85	7	36.248.07
97	8	36.248.08
121	10	36.248.10
145	12	36.248.12

Passende Schrauben / Recommended Screws:	
Kortikal ø 3,5 mm	36.204.10 - 36.204.95
Spongiosa ø 3,5 mm	36.206.08 - 36.206.65

Orthopedic



**TUFFRO**

The Mangalm Surgical Co.

**Orthopedic**



Plattenlänge 92 mm · Length of plate 92 mm		
Klingenlänge mm Length of blades mm	Locharzahl No. of holes	Artikel Nr. Cat. No.
50	5	<b>36.231.50</b>
60	5	<b>36.231.52</b>
70	5	<b>36.231.54</b>
80	5	<b>36.231.56</b>

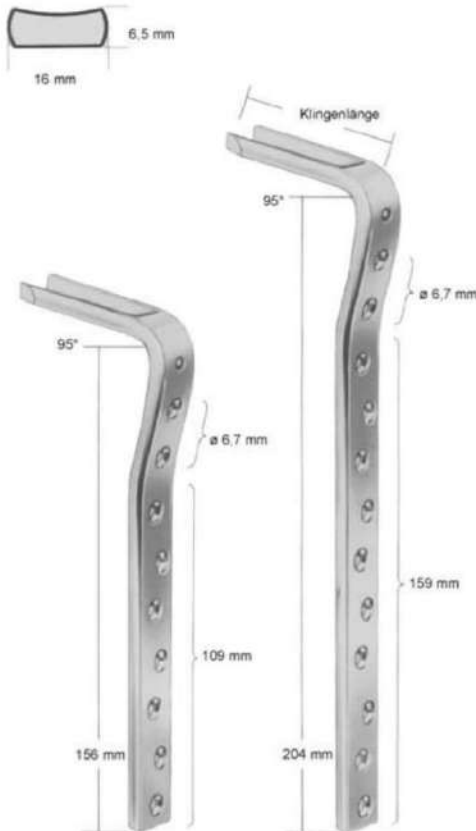

Plattenlänge 124 mm · Length of plate 124 mm		
Klingenlänge mm Length of blades mm	Locharzahl No. of holes	Artikel Nr. Cat. No.
50	7	<b>36.231.70</b>
60	7	<b>36.231.72</b>
70	7	<b>36.231.74</b>
80	7	<b>36.231.76</b>

Plattenlänge 156 mm · Length of plate 156 mm		
Klingenlänge mm Length of blades mm	Locharzahl No. of holes	Artikel Nr. Cat. No.
50	9	<b>36.231.90</b>
60	9	<b>36.231.92</b>
70	9	<b>36.231.94</b>
80	9	<b>36.231.96</b>

Plattenlänge 204 mm · Length of plate 204 mm		
Klingenlänge mm Length of blades mm	Locharzahl No. of holes	Artikel Nr. Cat. No.
50	12	<b>36.231.20</b>
60	12	<b>36.231.22</b>
70	12	<b>36.231.24</b>
80	12	<b>36.231.26</b>

Passende Schrauben / Recommended Screws:	
Kortikal ø 4,5 mm	<b>36.214.14 - 36.214.80</b>
Malleolar ø 4,5 mm	<b>36.215.20 - 36.215.80</b>
Spongiosa / Cancellous ø 6,5 mm	für die oberen 2 Löcher geeignet the 2 holes next blade accepted

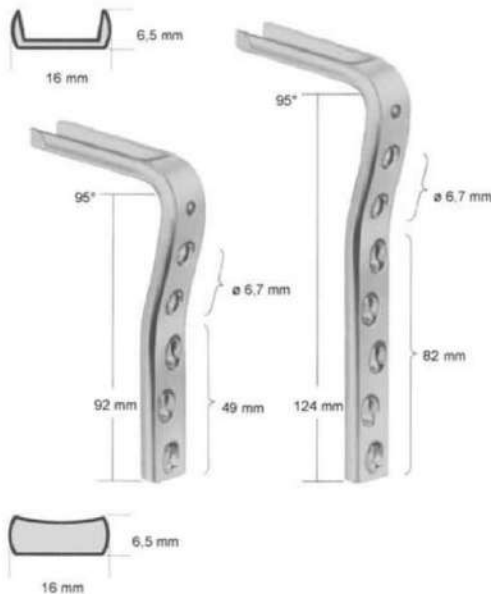

Plattenlänge 92 mm - Length of plate 92 mm		
Klingenlänge mm Length of blades mm	Lochanzahl No. of holes	Artikel Nr. Cat. No.
50	5	36.237.50
60	5	36.237.52
70	5	36.237.54
80	5	36.237.56

Plattenlänge 124 mm - Length of plate 124 mm		
Klingenlänge mm Length of blades mm	Lochanzahl No. of holes	Artikel Nr. Cat. No.
50	7	36.237.70
60	7	36.237.72
70	7	36.237.74
80	7	36.237.76

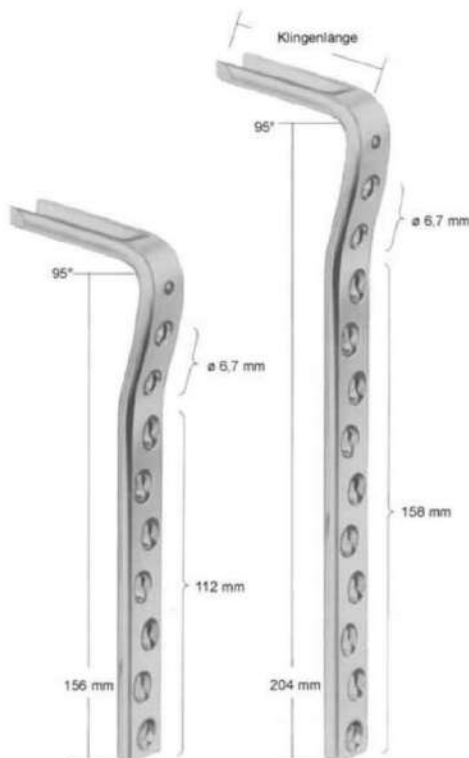

Plattenlänge 156 mm - Length of plate 156 mm		
Klingenlänge mm Length of blades mm	Lochanzahl No. of holes	Artikel Nr. Cat. No.
50	9	36.237.90
60	9	36.237.92
70	9	36.237.94
80	9	36.237.96

Plattenlänge 204 mm - Length of plate 204 mm		
Klingenlänge mm Length of blades mm	Lochanzahl No. of holes	Artikel Nr. Cat. No.
50	12	36.237.20
60	12	36.237.22
70	12	36.237.24
80	12	36.237.26

Passende Schrauben / Recommended Screws:	
Kortikal $\varnothing$ 4,5 mm	36.214.14 - 36.214.80
Malleolar $\varnothing$ 4,5 mm	36.215.20 - 36.215.80
Spongiosa / Cancellous $\varnothing$ 6,5 mm	für die oberen 2 Löcher geeignet the 2 holes next blade accepted



**TUFFRO**

The Mangalm Surgical Co.

**Orthopedic**



Klingenlänge mm Length of blades mm	Artikel Nr. Cat. No.
70	36.239.70
75	36.239.75
80	36.239.80
85	36.239.85
90	36.239.90
95	36.239.95
100	36.240.00
105	36.240.05
110	36.240.10

Passende Schrauben / Recommended Screws:

Kortikal ø 4,5 mm	36.214.14 - 36.214.80
-------------------	-----------------------

Ortho  
90



**TUFFRO**

The Mangalm Surgical Co.

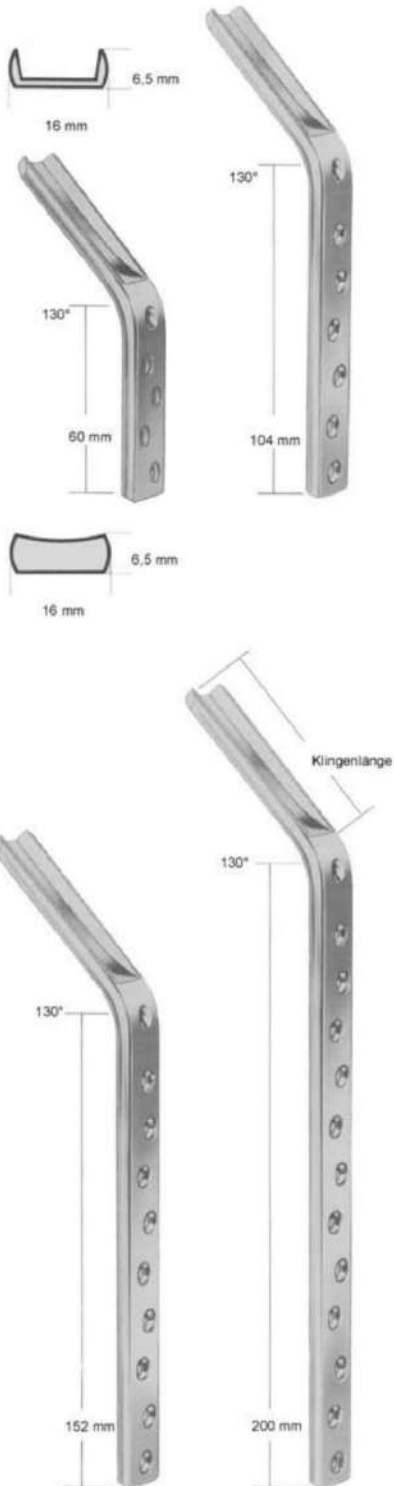

Plattenlänge 60 mm - Length of plate 60 mm		
Klingenlänge mm Length of blades mm	Lochanzahl No. of holes	Artikel Nr. Cat. No.
50	4	36.233.36
60	4	36.233.38
70	4	36.233.44
75	4	36.233.45
80	4	36.233.46
85	4	36.233.47
90	4	36.233.48
95	4	36.233.49
100	4	36.233.40
105	4	36.233.41
110	4	36.233.42

Plattenlänge 104 mm - Length of plate 104 mm		
Klingenlänge mm Length of blades mm	Lochanzahl No. of holes	Artikel Nr. Cat. No.
50	6	36.233.60
60	6	36.233.62
70	6	36.233.64
80	6	36.233.66
90	6	36.233.68

Plattenlänge 152 mm - Length of plate 152 mm		
Klingenlänge mm Length of blades mm	Lochanzahl No. of holes	Artikel Nr. Cat. No.
70	9	36.233.94
80	9	36.233.96
90	9	36.233.98

Plattenlänge 200 mm - Length of plate 200 mm		
Klingenlänge mm Length of blades mm	Lochanzahl No. of holes	Artikel Nr. Cat. No.
70	12	36.233.24
80	12	36.233.26
90	12	36.233.28

Passende Schrauben / Recommended Screws:	
Kortikal ø 4,5 mm	36.214.14 - 36.214.80

Orthopedic



**TUFFRO**

The Mangalm Surgical Co.

**Orthopedic**

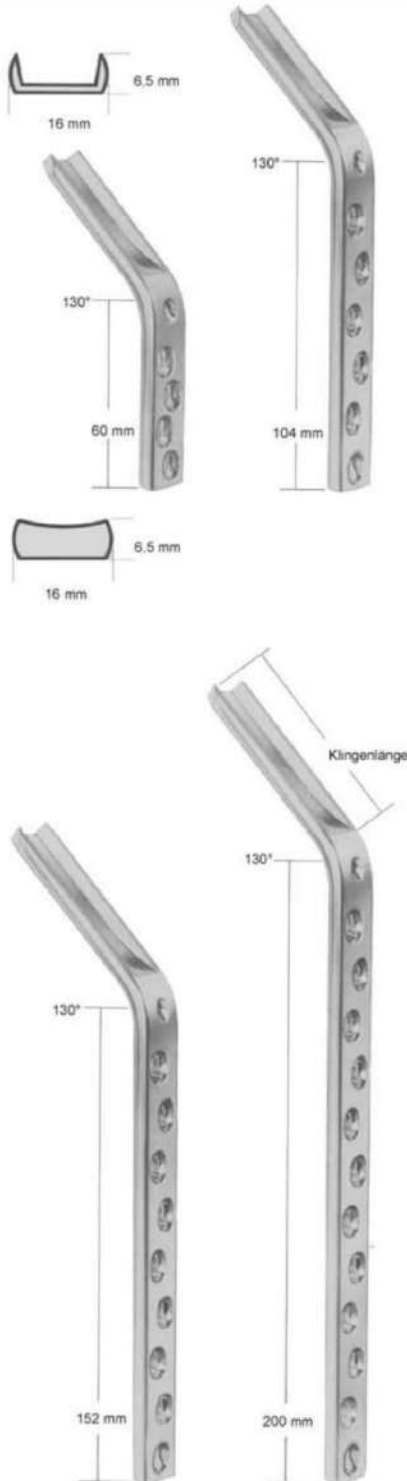

Plattenlänge 60 mm · Length of plate 60 mm		
Klingenlänge mm Length of blades mm	Lochanzahl No. of holes	Artikel Nr. Cat. No.
50	4	36.238.36
60	4	36.238.38
70	4	36.238.44
75	4	36.238.45
80	4	36.238.46
85	4	36.238.47
90	4	36.238.48
95	4	36.238.49
100	4	36.238.40
105	4	36.238.41
110	4	36.238.42

Plattenlänge 104 mm · Length of plate 104 mm		
Klingenlänge mm Length of blades mm	Lochanzahl No. of holes	Artikel Nr. Cat. No.
50	6	36.238.60
60	6	36.238.62
70	6	36.238.64
80	6	36.238.66
90	6	36.238.68

Plattenlänge 152 mm · Length of plate 152 mm		
Klingenlänge mm Length of blades mm	Lochanzahl No. of holes	Artikel Nr. Cat. No.
70	9	36.238.94
80	9	36.238.96
90	9	36.238.98

Plattenlänge 200 mm · Length of plate 200 mm		
Klingenlänge mm Length of blades mm	Lochanzahl No. of holes	Artikel Nr. Cat. No.
70	12	36.238.24
80	12	36.238.26
90	12	36.238.28

Passende Schrauben / Recommended Screws:	
<ortikal ø 4,5 mm	36.214.14 - 36.214.80



**TUFFRO**

The Mangalm Surgical Co.

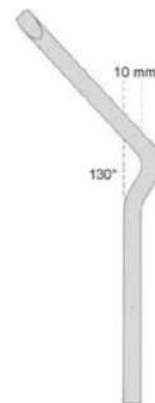

**Orthopedic**

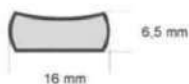

Klingenlänge mm Length of blades mm	110°	120°	130°
65	36.363.65	36.365.65	36.367.65
70			36.367.10
75	36.363.75	36.365.75	36.367.75
80			36.367.80
85	36.363.85	36.365.85	36.367.85
90			36.367.90
95			36.367.96
100			36.368.00
105			36.368.05
110			36.368.70

Passende Schrauben / Recommended Screws:

Kortikal ø 4,5 mm	36.214.14 - 36.214.80
-------------------	-----------------------





**TUFFRO**

The Mangalm Surgical Co.

**Orthopedic**

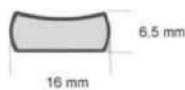
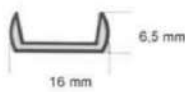
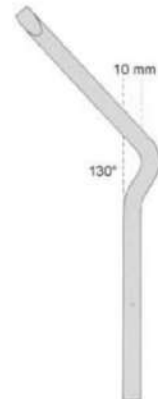

Klingenlänge mm Length of blades mm	110°	120°	130°
65	<b>36.373.65</b>	<b>36.375.65</b>	<b>36.377.65</b>
70			<b>36.377.70</b>
75	<b>36.373.75</b>	<b>36.375.75</b>	<b>36.377.75</b>
80			<b>36.377.80</b>
85	<b>36.373.85</b>	<b>36.375.85</b>	<b>36.377.85</b>
90			<b>36.377.90</b>
95			<b>36.377.96</b>
100			<b>36.378.00</b>
105			<b>36.378.05</b>
110			<b>36.378.70</b>

Passende Schrauben / Recommended Screws:	
Kortikal ø 4,5 mm	<b>36.214.14 - 36.214.80</b>



**TUFFRO**

The Mangalm Surgical Co.

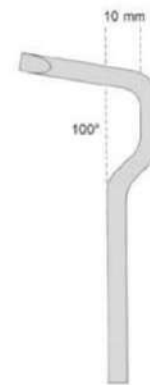
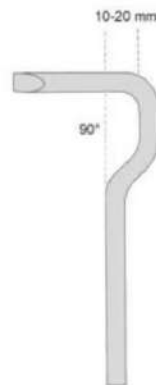
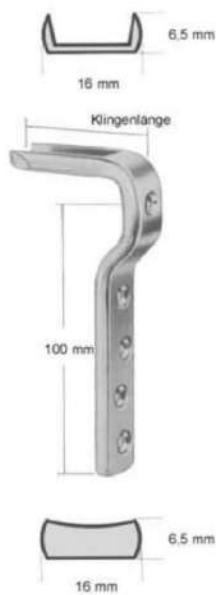

Klingenlänge mm Length of blades mm	Bogentiefe Displacement	90°	100°
40	10	<b>36.408.40</b>	
50	15	<b>36.408.50</b>	
60	15	<b>36.408.60</b>	
60	20	<b>36.409.60</b>	
60	10		<b>36.410.60</b>

Passende Schrauben / Recommended Screws:

Kortikal ø 4,5 mm	<b>36.214.14 - 36.214.80</b>
-------------------	------------------------------

**Orthopedic**



**TUFFRO**

The Mangalm Surgical Co.

**Orthopedic**

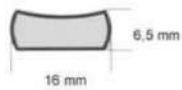
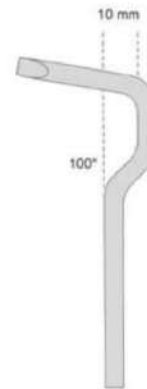
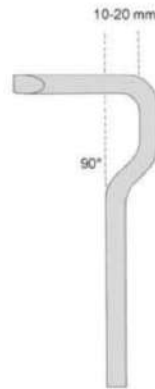

Klingenlänge mm Length of blades mm	Bogentiefe Displacement	90°	100°
40	10	<b>36.418.40</b>	
50	15	<b>36.418.50</b>	
60	15	<b>36.418.60</b>	
60	20	<b>36.419.60</b>	
60	10		<b>36.420.60</b>

Passende Schrauben / Recommended Screws:	
Kortikal ø 4,5 mm	<b>36.214.14 - 36.214.80</b>

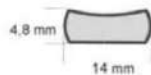
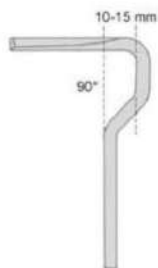
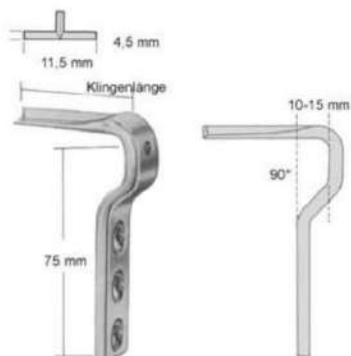

Klingenlänge mm Length of blades mm	Bogentiefe Displacement	90°
40	10	<b>36.440.40</b>
50	10	<b>36.440.50</b>
40	15	<b>36.441.40</b>
50	15	<b>36.441.50</b>

Passende Schrauben / Recommended Screws:	
Kortikal ø 4,5 mm	<b>36.214.14 - 36.214.80</b>



**TUFFRO**

The Mangalm Surgical Co.

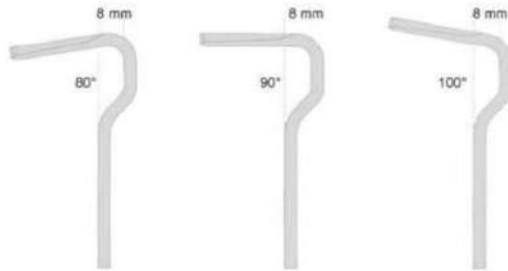

Klingenlänge mm Length of blades mm	80°	90°	100°
35	36.433.35	36.434.35	36.435.35
45	36.433.45	36.434.45	36.435.45

Passende Schrauben / Recommended Screws:	
Kortikal ø 4,5 mm	36.214.14 - 36.214.80
Malleolar ø 4,5 mm	36.215.20 - 36.215.80

**Orthopedic**



Klingenlänge mm Length of blades mm	Bogentiefe Displacement	90°
25	7	36.436.25
32	7	36.436.32
25	12	36.438.25
32	12	36.438.32

Passende Schrauben / Recommended Screws:	
Kortikal ø 3,5 mm	36.204.08 - 36.204.95
Spongiosa ø 4,0 mm Cancellous ø 4,0 mm	36.207.10 - 36.207.50



**TUFFRO**

The Mangalm Surgical Co.

**Orthopedic**

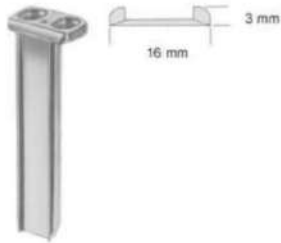

Klingenplatten  
Blade Plates

- |           |       |
|-----------|-------|
| 36.800.50 | 50 mm |
| 36.800.60 | 60 mm |
| 36.800.70 | 70 mm |



Klingenmeißel  
Seating Chisel



Einschlaginstrument  
Final Impactor

33.588.21  
21,0 cm / 8½"



**TUFFRO**

The Mangalm Surgical Co.

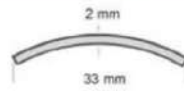

Länge mm Length mm	Lochanzahl No. of holes	Artikel Nr. Cat. No.
100	5	<b>36.510.05</b>
120	6	<b>36.512.06</b>

Passende Schrauben / Recommended Screws:	
Kortikal ø 4,5 mm	<b>36.214.14 - 36.214.80</b>

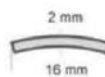
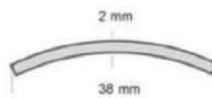

Länge mm Length mm	Lochanzahl No. of holes	Artikel Nr. Cat. No.
68	3	<b>36.516.03</b>
84	4	<b>36.516.04</b>
105	5	<b>36.516.05</b>
116	6	<b>36.516.06</b>
148	8	<b>36.516.08</b>

Passende Schrauben / Recommended Screws:	
Kortikal ø 4,5 mm	<b>36.214.14 - 36.214.80</b>

**Orthopedic**



**TUFFRO**

The Mangalm Surgical Co.

**Orthopedic**

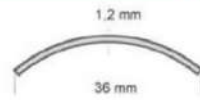

Länge mm Length mm	Lochanzahl No. of holes	Artikel Nr. Cat. No.
88	3	<b>36.520.03</b>
105	4	<b>36.520.04</b>

Passende Schrauben / Recommended Screws:

Kopf / Head

Spongiosa $\varnothing$ 3,5 mm Cancellous $\varnothing$ 3,5 mm	<b>36.206.08 - 36.206.65</b>
---	------------------------------

Schaft / Shaft

Kortikal $\varnothing$ 4,5 mm	<b>36.214.14 - 36.214.80</b>
-------------------------------	------------------------------

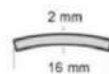
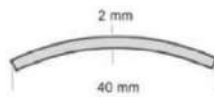

Länge mm Length mm	Lochanzahl No. of holes	Artikel Nr. Cat. No.
80	4	<b>36.526.04</b>
103	5	<b>36.526.05</b>
116	6	<b>36.526.06</b>

Passende Schrauben / Recommended Screws:

Kortikal $\varnothing$ 4,5 mm	<b>36.214.14 - 36.214.80</b>
-------------------------------	------------------------------



**TUFFRO**

The Mangalm Surgical Co.

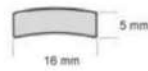

Länge mm Length mm	Lochanzahl No. of holes	Artikel Nr. Cat. No.
170	8	36.445.08
186	9	36.445.09
202	10	36.445.10
218	11	36.445.11

Passende Schrauben / Recommended Screws:	
Kortikal ø 3,5 mm	36.214.14 - 36.214.80
Malleolar ø 4,5 mm	36.215.20 - 36.215.80
Spongiosa ø 6,5 mm	36.216.00 - 36.216.95
Cancelous ø 6,5 mm	36.217.00 - 36.217.95
	36.218.00 - 36.218.95

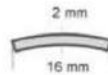
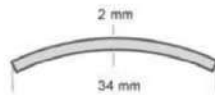

Länge mm Length mm	Lochanzahl No. of holes	Artikel Nr. Cat. No.
87	4 links, left	36.529.01
87	4 rechts, right	36.529.02

Passende Schrauben / Recommended Screws:	
Kortikal ø 4,5 mm	36.214.14 - 36.214.80

**Orthopedic**